

BD FACSCanto II Flow Cytometer Reference Manual

For In Vitro Diagnostic Use

bdbiosciences.com
Part No. 640806 Rev. A
May 2006



BD Biosciences
2350 Qume Drive
San Jose, CA 95131-1807
USA
Tel (877) 232-8995
Fax (408) 954-2347

Asia Pacific
Tel (65) 6-861-0633
Fax (65) 6-860-1590

Europe
Tel (32) 53-720211
Fax (32) 53-720452

Brazil
Tel (55) 11-5185-9995
Fax (55) 11-5185-9895

Japan
Nippon Becton Dickinson Company, Ltd.
Tel 0120-8555-90

Canada
Tel (888) 259-0187
(905) 542-8028
Fax (905) 542-9391
canada@bd.com

Mexico
Tel (52) 55 5999 8296
Fax (52) 55 5999 8288

© 2006, Becton, Dickinson and Company. All rights reserved. No part of this publication may be reproduced, transmitted, transcribed, stored in retrieval systems, or translated into any language or computer language, in any form or by any means: electronic, mechanical, magnetic, optical, chemical, manual, or otherwise, without prior written permission from BD Biosciences.

The information in this guide is subject to change without notice. BD Biosciences reserves the right to change its products and services at any time to incorporate the latest technological developments. Although this guide has been prepared with every precaution to ensure accuracy, BD Biosciences assumes no liability for any errors or omissions, nor for any damages resulting from the application or use of this information. BD Biosciences welcomes customer input on corrections and suggestions for improvement.

BD FACSDiva software © Becton, Dickinson and Company. This software is the property of Becton, Dickinson and Company. Each sale of a stored unit of this software grants the purchaser a nontransferable, nonexclusive, personal license. This software may not be duplicated, reproduced, or copied in any form or by any means whatsoever, except as otherwise permitted by law.

BD FACSCanto clinical software © Becton, Dickinson and Company. This software is the property of Becton, Dickinson and Company. Each sale of a stored unit of this software grants the purchaser a nontransferable, nonexclusive, personal license. This software may not be duplicated, reproduced, or copied in any form or by any means whatsoever, except as otherwise permitted by law.

BD, the BD logo, BD Calibrite, BD FACS, BD FACSCalibur, BD FACSCanto, BD FACSDiva, BD FACSFlow, BD Falcon, BD Multiset, BD Multitest, and BD Trucount are trademarks of Becton, Dickinson and Company.

JDS Uniphase is a trademark of JDS Uniphase, Inc.

Alexa Fluor and Texas Red are registered trademarks, and Pacific Blue is a trademark of Molecular Probes, Inc.

iFLEX is a trademark of Point Source, Ltd.

Microsoft and Windows are registered trademarks of Microsoft Corporation.

Sapphire is a trademark and Coherent is a registered trademark of COHERENT, INC.

Teflon is a registered trademark of E.I. du Pont de Nemours and Company.

All other company and product names might be trademarks of the respective companies with which they are associated.

Patents

PE and APC: US 4,520,110; 4,859,582; 5,055,556; Europe 76,695; Canada 1,179,942

PerCP: US 4,876,190

Cy5.5 and Cy7: US 5,268,486; 5,486,616; 5,569,587; 5,569,766; and 5,627,027

Pe-Cy7: US 4,542,104

APC-Cy7: US 5,714,386

FCC Information

WARNING: Changes or modifications to this unit not expressly approved by the party responsible for compliance could void the user's authority to operate the equipment.

NOTICE: This equipment has been tested and found to comply with the limits for a Class A digital device, pursuant to Part 15 of the FCC Rules. These limits are designed to provide reasonable protection against harmful interference when the equipment is operated in a commercial environment. This equipment generates, uses, and can radiate radio frequency energy and, if not installed and used in accordance with the instruction manual, can cause harmful interference to radio communications. Operation of this equipment in a residential area is likely to cause harmful interference in which case the user will be required to correct the interference at his or her own expense.

Shielded cables must be used with this unit to ensure compliance with the Class A FCC limits.

This Class A digital apparatus meets all requirements of the Canadian Interference-Causing Equipment Regulations.

Cet appareil numérique de la classe A respecte toutes les exigences du Règlement sur le matériel brouilleur du Canada.

Notice

BD Biosciences delivers software and workstations that are intended for running the instruments supplied by BD Biosciences. It is the responsibility of the buyer/user to ensure that all added electronic files including software and transport media are virus free. If the workstation is used for Internet access or purposes other than those specified by BD Biosciences, it is the buyer/user's responsibility to install and maintain up-to-date virus protection software. BD Biosciences does not make any warranty with respect to the workstation remaining virus free after installation. BD Biosciences is not liable for any claims related to or resulting from buyer/user's failure to install and maintain virus protection.

History

Revision	Date	Change Made
640806 Rev. A	5/06	Initial release

Contents

About This Manual	ix
Conventions	x
Technical Assistance	xi
Chapter 1: Introduction	13
Intended Use	14
System Components	15
Flow Cytometer	16
Fluidics Cart	26
Computer Workstation	29
BD FACS Loader (Optional)	29
Barcode Reader (Optional)	30
System Requirements	31
Chapter 2: BD FACS Loader Option	33
Loader Components	34
Using the Loader	36
Opening and Closing the Loader Doors	36
Acquiring with the Loader	37
Changing Operational Modes	40
Maintaining the Loader	42
Spill Containment Area	42
Cleaning External Surfaces	43

Chapter 3: Barcode Reader Option	45
Installing and Using the Barcode Reader	46
Cleaning the Barcode Reader	48
Barcode Symbologies	49
1D Barcode Symbologies	49
2D Barcode Symbologies	50
Chapter 4: Maintenance	51
Scheduled Maintenance	52
Emptying the Waste Container	54
Purging the Fluidics Filters	57
Decontaminating the Fluidics System (Long Clean)	59
Replacing the Air Filter	60
Replacing Fluidics Filters	63
Unscheduled Maintenance	66
Changing a Cubitainer	68
Removing an Air Lock	72
Cleaning External Surfaces	74
Removing Bubbles from the Flow Cell	76
Cleaning the Flow Cell	76
Purging the Bubble Filter	78
Decontaminating the Fluidics System for Storage	79
Replacing the Bal Seal	79
Resetting the Cytometer Circuit Breaker	85
Reconnecting the Ethernet and RS232 Cables	86
Reconnecting the Fluidics Cart Tubing	86
Replacing the Fluidics Level Sensors	89
Replacing the Fluidics Cart Fuses	92

Chapter 5: Troubleshooting	95
Instrument Troubleshooting	96
Fluidics Cart Troubleshooting	101
Loader Troubleshooting	102
Appendix A: Technical Overview	105
Flow Cytometry	106
Fluidics System	106
Optics System	109
Light Scatter	110
Fluorescence	111
Optical Filters	112
Detectors	114
Detector Arrays	114
Spillover	117
Electronics System	119
Pulses	120
Pulse Measurements	121
Appendix B: Optics Configurations	125
4-2 Optics Configuration	126
4-2-2 Optics Configuration	130
5-3 Optics Configuration	134

Appendix C: Supplies and Replacement Parts	139
Instrument Supplies	140
Installation Kit	140
Other Replacement Parts	141
Bar Code Reader Parts	141
Consumables	142
Instrument Setup	142
Reagents	142
Labware	143
Appendix D: Technical Specifications	145
Cytometer Specifications	146
Environment	147
Performance	147
Optics	147
Fluidics	149
Signal Processing	149
Fluidics Cart Specifications	150
Capacity	150
BD FACS Loader Specifications	151
Index	153

About This Manual

This manual contains reference information about the BD FACSCanto™ II flow cytometer and the BD FACSTM Loader. Operating instructions are contained in the *BD FACSCanto II Instructions for Use*.

Most instrument functions are controlled by BD FACSCanto™ clinical software and BD FACSDiva™ software. BD FACSCanto clinical software contains modules for dedicated clinical applications with automatic gating algorithms, while BD FACSDiva software is non-application specific. You can use either software to perform instrument quality control. Each software package has its own reference manual, provided on the documentation CD.





BD Biosciences recommends that first-time users of this instrument take advantage of operator training offered with the sale of every new instrument.

The *BD FACSCanto II Flow Cytometer Reference Manual* assumes you have a working knowledge of basic Microsoft® Windows® operation. If you are not familiar with the Windows operating system, refer to the documentation provided with your computer.

Conventions

The following tables list conventions used in this manual. Table 1 lists symbols that are used in this manual or on safety labels to alert you to a potential hazard. Text and keyboard conventions are shown in Table 2.

Table 1 Hazard symbols^a

Symbol	Meaning
	CAUTION: hazard or unsafe practice that could result in material damage, data loss, minor or severe injury, or death
	Electrical danger
	Laser radiation
	Biological risk

a. Although these symbols appear in color on the instrument, they are in black and white throughout this reference manual; their meaning remains unchanged.

Table 2 Text and keyboard conventions

Convention	Use
 Tip	Features or hints that can save time or prevent difficulties
NOTICE	Provides information that supplements the topic material
<i>Italics</i>	Book titles and new or unfamiliar terms
>	Menu selection For example, “select File > Print” means select Print from the File menu.
Ctrl-X	Press the indicated keys simultaneously For example, Ctrl-P means hold down the Control key while pressing the letter <i>p</i> .

Technical Assistance

For technical questions or assistance in solving a problem:

- Read the section of the manual specific to the operation you are performing.
- See Chapter 5, Troubleshooting.

If additional assistance is required, contact your local BD Biosciences technical support representative or supplier.

When contacting BD Biosciences, have the following information available:

- product name, part number, and serial number
- software version number
- error messages
- details of system performance

For instrument support within the US, call (877) 232-8995.

For support within Canada, call (888) 259-0187.

Customers outside the US and Canada, contact your local BD representative or distributor.

Introduction

The BD FACSCanto II system uses a fixed-optics design and advanced digital electronics to support multicolor analysis of up to eight fluorescent markers and two scatter parameters per assay.

The instrument does not require special facilities—it plugs into a standard wall outlet, uses air-cooled lasers, and provides its own air pressure and vacuum for the fluidics and waste. You can prepare samples on the BD FACS™ Sample Prep Assistant II and import the sample prep worklist.

For further automation, use BD FACSCanto clinical software and the BD FACS Loader for sample acquisition. Alternatively, use BD FACSDiva software for more flexibility in acquisition and analysis.

See the following for more information:

- Intended Use on page 14
- System Components on page 15
- System Requirements on page 31

Intended Use

The BD FACSCanto II system is intended for use as an In Vitro Diagnostic device for identification and enumeration of lymphocyte subsets in human cells in suspension for flow cytometry.

System Components

The BD FACSCanto II system consists of a benchtop flow cytometer, a self-contained fluidics cart, and the BD FACSCanto II workstation. System options include an automated sample loader and a barcode reader.

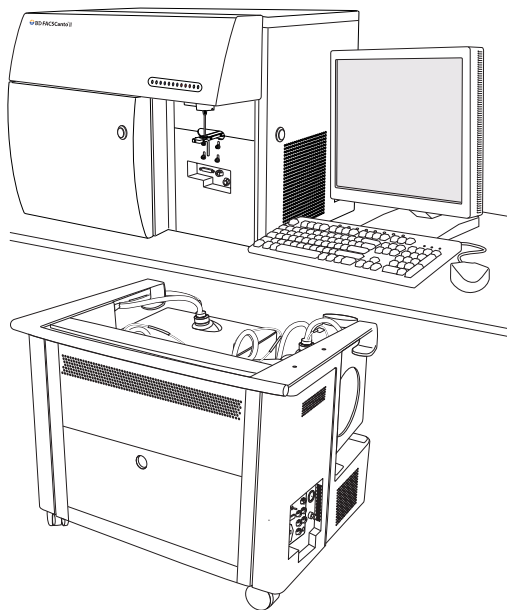

For a description of system components, see:

- Flow Cytometer on page 16
- Fluidics Cart on page 26
- Computer Workstation on page 29
- BD FACS Loader (Optional) on page 29
- Barcode Reader (Optional) on page 30

Flow Cytometer

Cytometer power is controlled by the power button. All other cytometer and fluidics cart functions are controlled by BD FACSCanto clinical software and BD FACSDiva software (provided with the instrument).

Figure 1-1 BD FACSCanto II flow cytometer

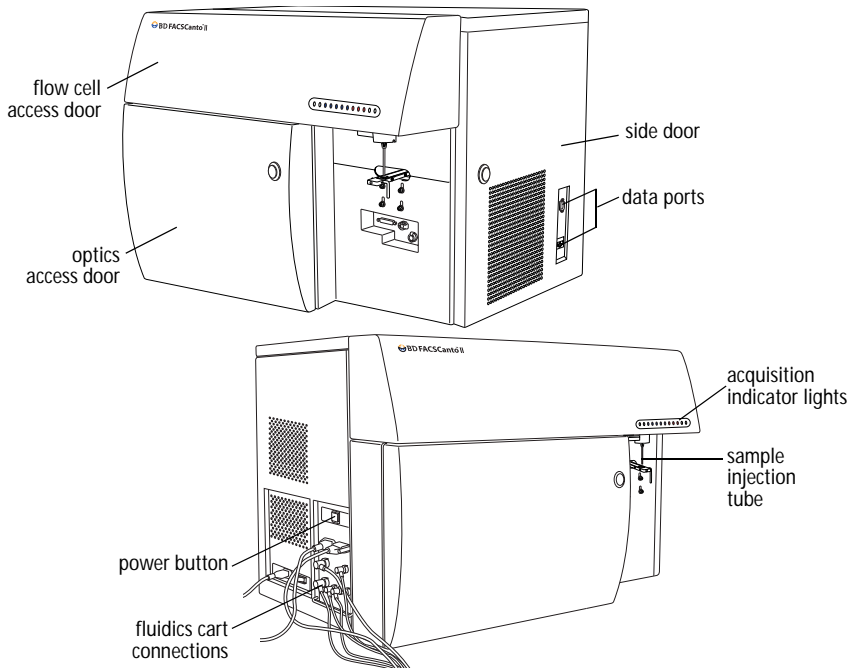

The BD FACSCanto II flow cytometer consists of a fluidics subsystem, an optics subsystem, and an electronics subsystem. For a more in-depth discussion of fluidics, optics, electronics, and flow cytometry, see the Technical Overview on page 105.

Fluidics

The fluidics system consists of the sample injection tube (SIT), the aspirator arm, the flow cell, a pressurized interior reservoir (plenum), and a network of tubing that provides sheath and cleaning fluids to and removes waste from the flow cell.

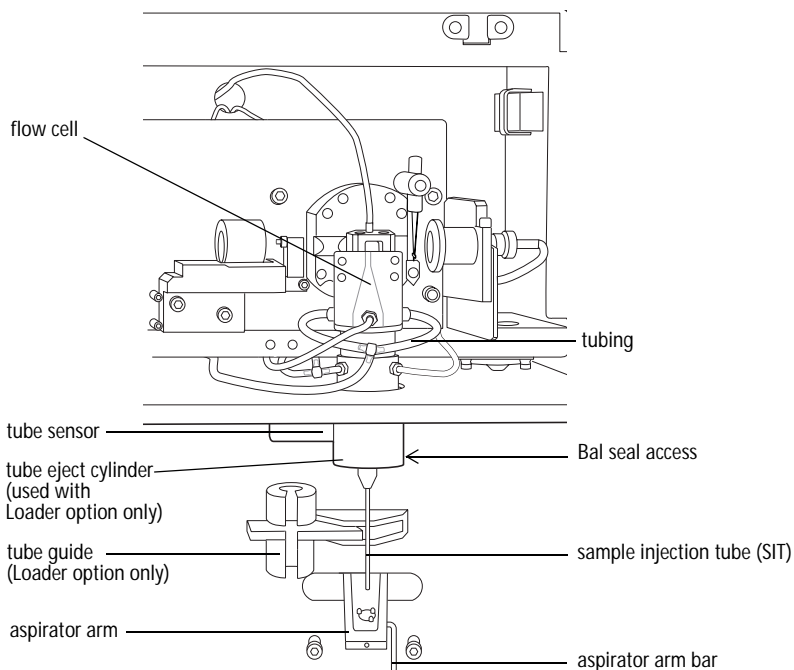

The following table briefly describes these components.

flow cell	where laser beam intercepts particles
tubing	brings sheath and cleaning fluids to and aspirates waste from flow cell
SIT	hollow metal tube that brings sample to flow cell
aspirator arm	movable waste aspiration port
aspirator arm bar	metal bar used to push aspirator arm away from SIT during manual loading
tube guide	helps guide tube onto the SIT (Loader operation only)
tube eject cylinder	ejects tube (Loader operation only)
tube sensor	detects tube position on SIT

When you install tubes onto the SIT, a pump within the fluidics cart pressurizes the plenum, which then provides sheath fluid to the flow cell. At the same time, the sample tube is pressurized and sample is pushed up the SIT and into the flow cell.

When you remove tubes from the SIT, the cytometer cleans the SIT by flushing sheath solution down the inside and outside of the tube. The flushed sheath solution is aspirated by the aspirator arm.

SIT cleaning between tubes is automatic when you use BD FACSCanto clinical software. In BD FACSDiva software, SIT cleaning between tubes is automatic unless you disable it by deselecting the SIT Flush checkbox on the Acquisition Dashboard.

Do not leave a tube of distilled water on the SIT between sample tubes, or during or after daily shutdown.

Never install a tube onto the SIT that contains more than 3 mL of fluid. This will cause the tube sensor to become wet and fail to properly sense tubes.

Flow Cell

Once the sample moves into the flow cell, particles move in single file through the laser beams. The scattered and emitted light from these particles provides information about their size, shape, granularity, and fluorescence properties.

The flow cell is behind the flow cell access door. For more information, see Fluidics System on page 106.

Figure 1-2 Flow cell

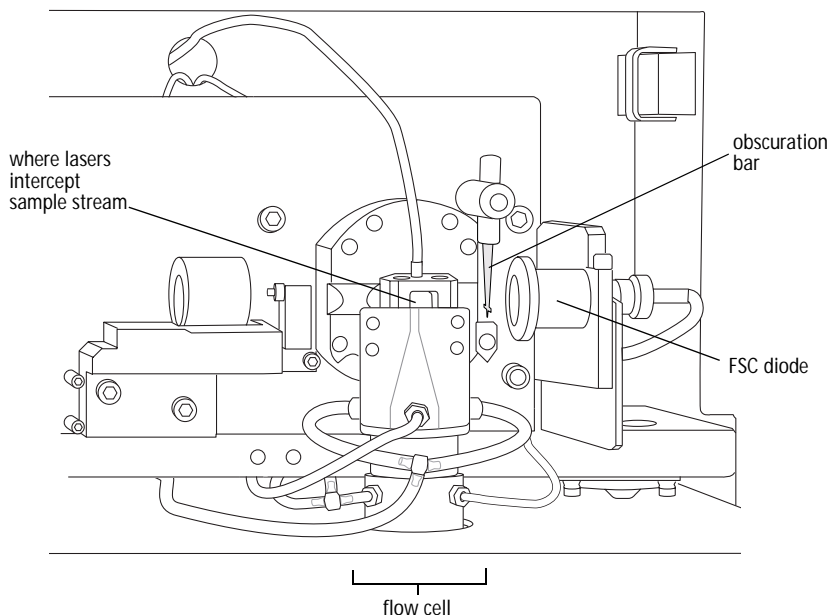

Optics

The optics system in the BD FACSCanto II cytometer is composed of both excitation optics and collection optics. Excitation optics bring light to the flow cell. Collection optics gather the light signals emitted or scattered by the particles.

Optics Configurations

Several optics configurations are available for the BD FACSCanto II cytometer. The 4-2 configuration can collect four fluorescence signals from a blue laser source and two fluorescence signals from a red laser source. The 4-2-2 configuration adds a violet laser and can collect two fluorescence signals from the violet laser source. The 5-3 configuration uses only the blue and red lasers, but can collect an additional fluorescence signal from each laser source.

The excitation and collection optics components for the 4-2 configuration are described in this section. The additional optics configurations and their components are described in Appendix B, Optics Configurations.

Excitation Optics

The excitation optics consist of lasers, fiber optic cables, beam-shaping prisms, and an achromatic focusing lens, as shown in Figure 1-3.

The BD FACSCanto II instrument uses low-powered air-cooled and solid state lasers that do not have special power and cooling requirements.

Table 1-1 4-2 configuration fluorochromes

Laser	Wavelength (nm)	Commonly Used Fluorochromes
Coherent® Sapphire™ Solid State	488 (blue)	FITC, PE, PE-Cy7, PerCP or PerCP-Cy5.5
JDS Uniphase™ HeNe Air Cooled	633 (red)	APC, APC-Cy7

Fiber optic cables direct the laser light onto beam-shaping prisms, which in turn transmit the laser light to a focusing lens. The lens directs the laser light onto the sample stream within the flow cell (Figure 1-3). See also Figure A-3 on page 109.

Figure 1-3 Optical pathway (figure shows violet laser available with 4-2-2 configuration only)

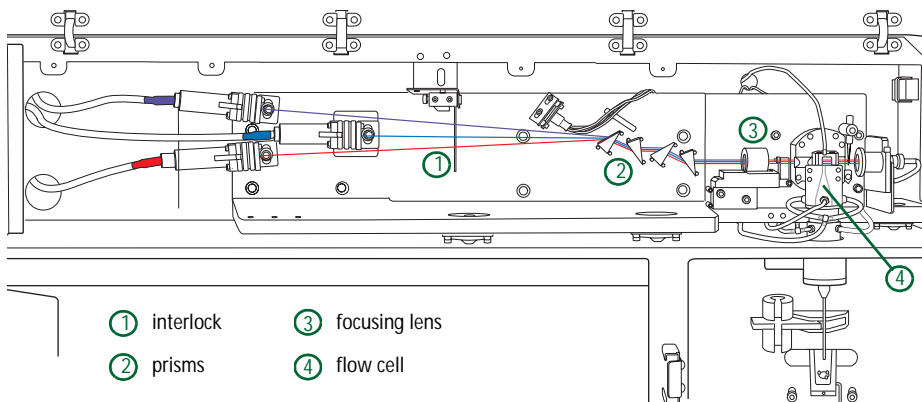

When the flow cell access door opens, an interlock shutters the laser light and blocks its pathway for safety reasons.

Collection Optics

From the flow cell, laser light is routed to the collection optics, which efficiently gather the signals emitted and scattered from each particle. The 4-2 configuration collection optics include two detector arrays, which consist of photomultiplier tubes (PMTs) arranged in one octagon and one trigon as shown in Figure 1-4.

The octagon contains five PMTs and detects light from the 488-nm (blue) laser. One PMT in the octagon collects side scatter (SSC) signals.

The trigon contains two PMTs and detects light from the 633-nm (red) laser.

Figure 1-4 Octagon and trigon detector arrays (4-2 configuration)

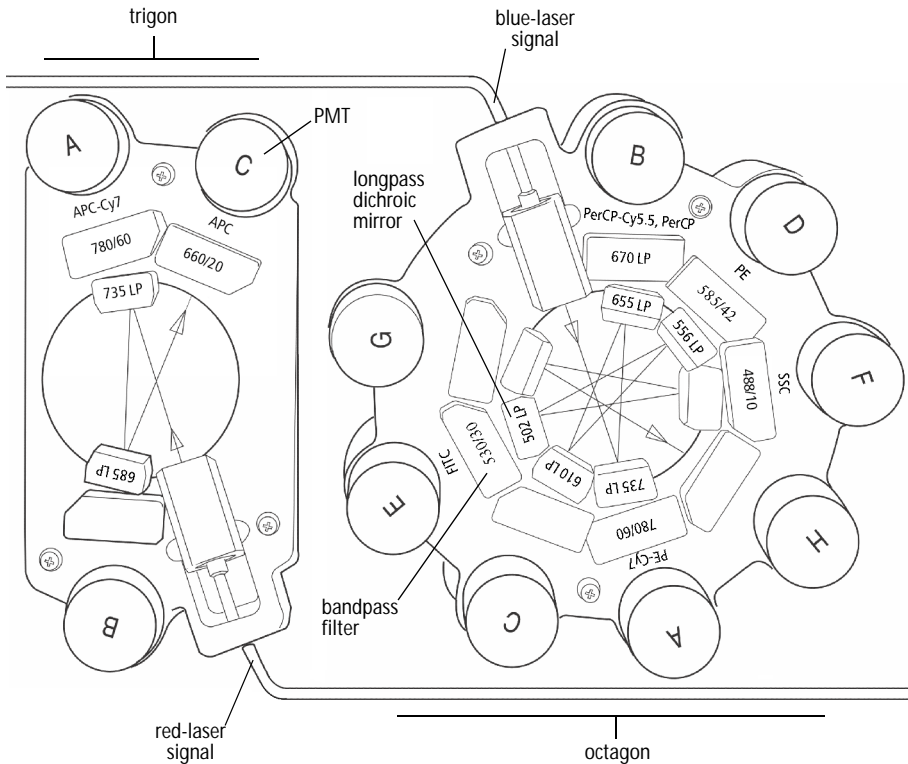

When light arrives at an array, a longpass mirror (filter) transmits the highest wavelengths to the first PMT in the series and reflects lower wavelengths to the next PMT. Similarly, the next PMT's longpass mirror transmits the next highest wavelengths and reflect lower wavelengths, and so on around the array. A bandpass filter (or additional longpass mirror) in front of each PMT further screens unwanted light.

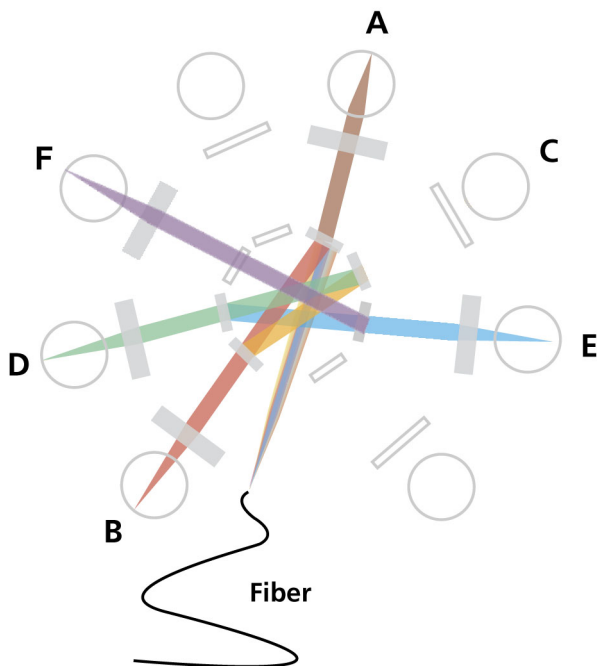

In addition to the PMT detectors, a photodiode collects the stronger forward scatter signals. The obscuration bar prevents excess laser light from entering this diode (see Figure 1-2 on page 19).

For additional descriptions of detector arrays, mirrors, and filters, see Optics System on page 109.

Some of the collection optics can be viewed by opening the optics access door. The 4-2 configuration octagon and trigon arrays have the filter and mirror combinations shown in Table 1-2.

Table 1-2 Octagon and trigon optical filters (4-2 configuration)

Detector Array (Laser)	PMT Position	LP Mirror	BP Filter or LP Mirror	Intended Dye
Octagon (488-nm blue laser)	A	735	780/60	PE-Cy7
	B	655	670	PerCP-Cy5.5 or PerCP
	C	610	blank optical holder	—
	D	556	585/42	PE
	E	502	530/30	FITC
	F	blank optical holder	488/10 and pinhole	SSC
	G	blank optical holder	blank optical holder	—
	H	—	blank optical holder	—
Trigon (633-nm red laser)	A	735	780/60	APC-Cy7
	B	685	blank optical holder	—
	C	—	660/20	APC

Blank optical holders do not contain optical filters. They are used in the octagon and trigon to prevent unwanted light from interfering with fluorescence signal.

Electronics

The electronics system converts optical signals to electronic signals and digitizes them for computer analysis. The photodiode and PMTs generate signals proportional to the amount of light they detect. The cytometer's onboard electronics amplifies and then converts the signals from continuous voltage values (analog) into discrete values (digital). Upon amplification and digital conversion, fluorescent light signals from consistently prepared and stained particles characteristically fall into certain channels, thus allowing analysis.

BD FACSCanto II electronic system components consist of power controls, connectors, the electronics processing board, the fluidics controllers, and the acquisition indicator lights. This section describes only the user-accessible power panel and the acquisition indicator lights. For more information, see Electronics System on page 119.

Power Panel

Power to the instrument, lasers, and fluidics cart is supplied by a power cord from the cytometer plugged directly into a standard electrical outlet. BD recommends using an uninterruptible power supply (UPS) unit to maintain instrument power during a power outage. The system power button turns on the instrument and fluidics cart, and powers the lasers.

Figure 1-5 Flow cytometer power panel

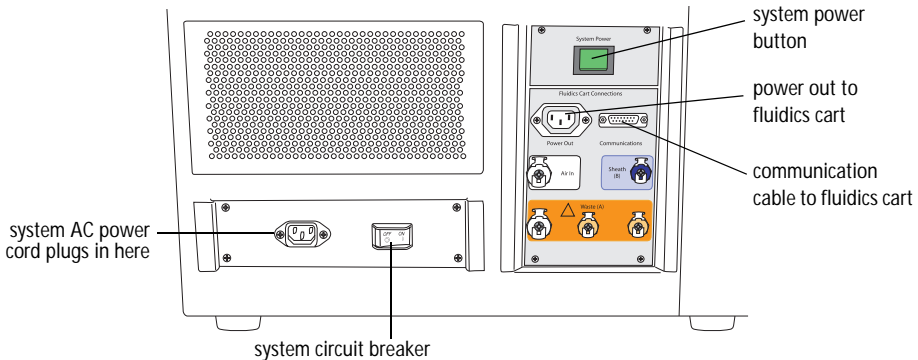

The system circuit breaker is located next to the AC power cord. The breaker will need to be reset if there is a power surge in the laboratory.

Acquisition Indicator Lights

The acquisition indicator lights are located on the flow cell access cover on the front of the cytometer (see Figure 1-1 on page 16). Each light corresponds to a detector in the collection optics subsystem, and blinks when the signal at that detector reaches a preset level (acquisition threshold levels override the presets).

Lights are activated only when the system is acquiring, and only the indicators corresponding to currently active parameters will blink.

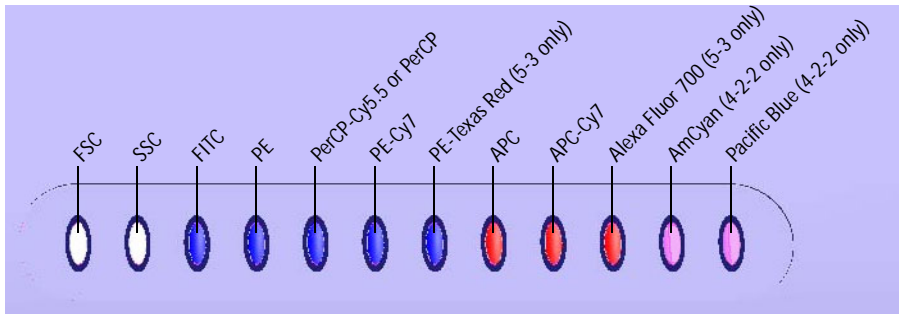

The acquisition indicator lights can be switched off. The on/off switch is located inside the flow cell access cover.

Figure 1-6 Acquisition indicator light switch

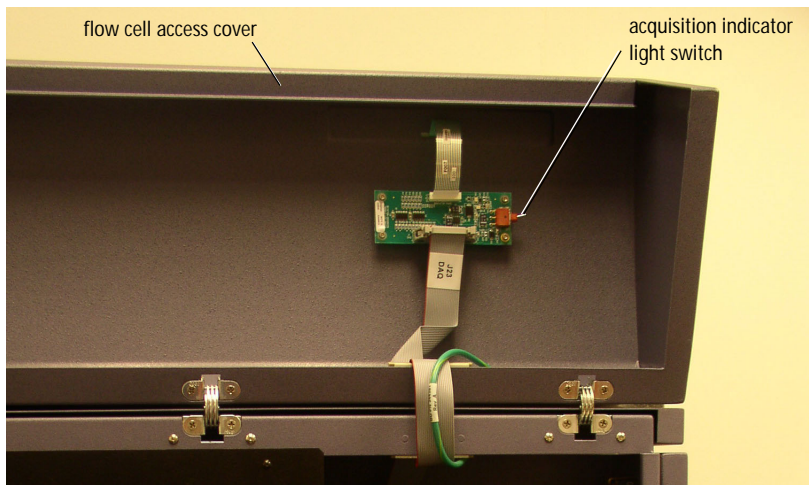

Fluidics Cart

The fluidics cart provides filtered sheath and cleaning fluids to the cytometer, and collects system waste products. The cart supplies the required air pressure and vacuum, which eliminates the need for an external source (although the cart can be hooked up to an in-house air source).

Figure 1-7 Fluidics cart

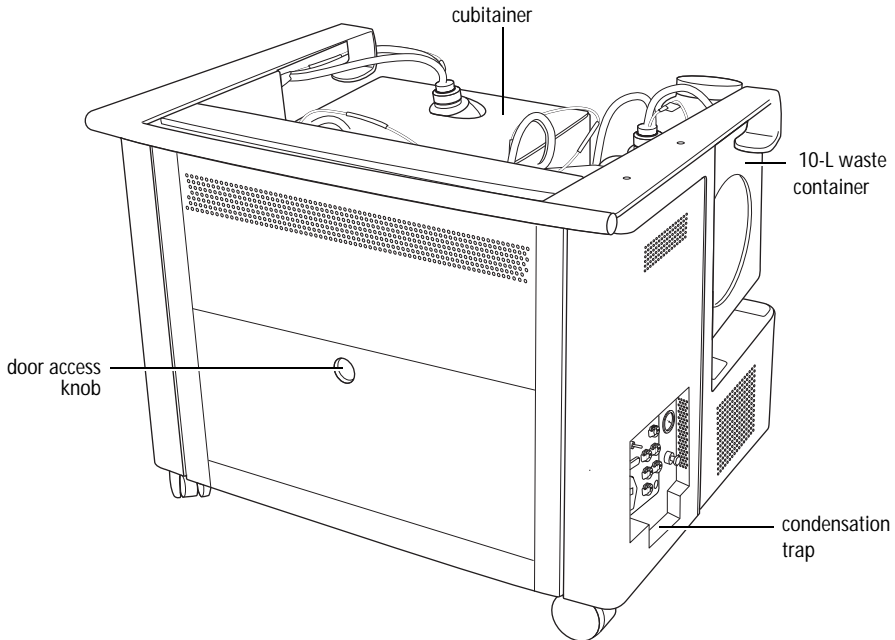

Containers and Ports

The fluidics cart holds a 10-L waste container, a 20-L BD FACSThrow™ cubitainer, a 5-L BD FACS shutdown solution cubitainer, and a 5-L BD FACSClean solution cubitainer.

Use the waste container provided with the system. Do not substitute other containers.

Figure 1-8 Fluidics cart containers and ports

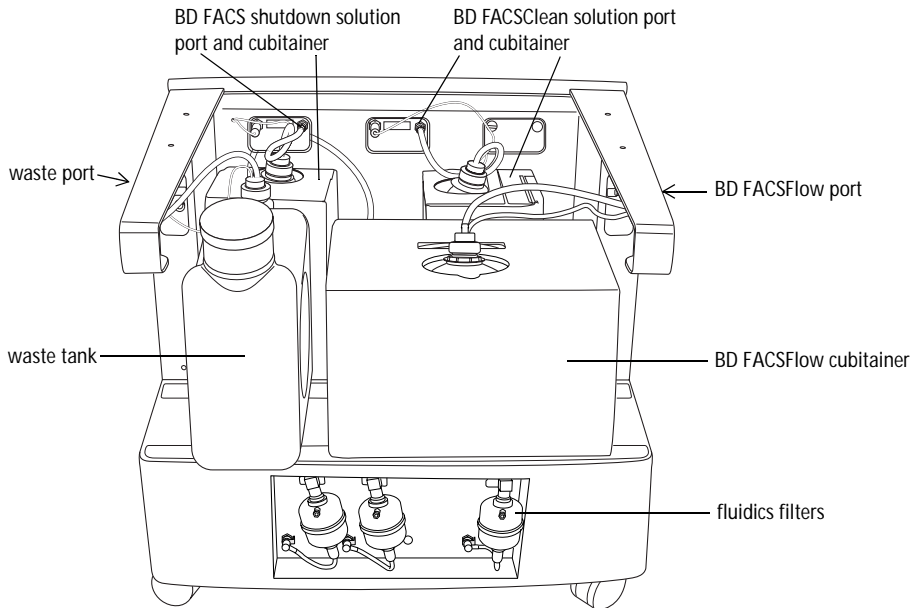

Each solution has its own non-interchangeable fluid port and level-sensor connection. Fluid level alarms occur within BD FACSThrow clinical software and BD FACSThrow software.

Controls

The fluidics cart connects to the flow cytometer unit by way of cables and tubing. When you turn on the power to the cytometer, the fluidics cart powers on also. Under ordinary circumstances, you do not need to adjust any of the switches on the cart's power panel. Leave the auxiliary air supply switch off unless the cart has been attached to an in-house air supply by BD Biosciences service personnel (see Table 1-3 for details). Leave the cart circuit breaker on at all times.

Figure 1-9 Fluidics cart panel

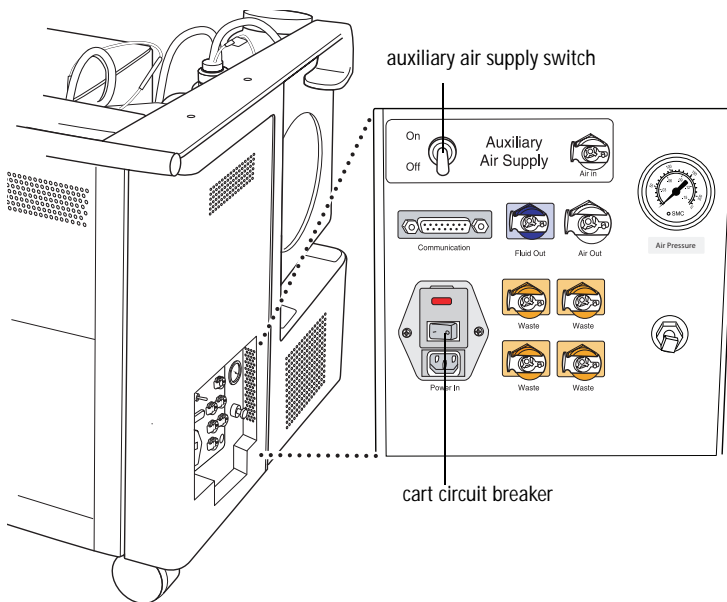

Table 1-3 Auxiliary air supply switch positions

Position	Air Source	Meaning
Off	Cart air	The cart is providing its own air pressure and vacuum.
On	House air	The cart is hooked up to the building's air pressure and vacuum.

Powering Off

To turn off the fluidics cart (and the cytometer, as well), press the system power button. Normally during cart shutdown, you hear a hiss, and a small amount of condensed water will discharge.

Condensation Trap

The fluidics cart condensation trap is located beneath the controls panel (see Figure 1-7 on page 26). Empty the trap during the daily startup procedure.

Computer Workstation

The workstation consists of a computer compatible with Microsoft Windows XP Professional operating system, a flat-screen monitor, and an optional printer.

BD FACS Loader (Optional)

The BD FACS Loader automatically introduces prepared samples to the cytometer. The Loader is controlled by BD FACSCanto clinical software or BD FACSDiva software. It can be added to your system at any time. The Loader consists of:

- a drawer
- sliding doors
- optical sensors
- an electronics module
- a tube lifter
- a 40-tube carousel
- tube guide (with sensor)

For more information, see BD FACS Loader Option on page 33.

Barcode Reader (Optional)

The Opticon LG2 Imager is a hand-held barcode reader that plugs into the USB port on the BD FACSCanto II computer workstation. A green light on the top of the barcode reader indicates that it is connected to the USB port and ready to use.

The barcode reader reads most barcode standards, including Codabar, Code 128, Code 39 with checksum, and PDF417. It reads information from the BD FACS™ 7-color setup beads label into BD FACSCanto clinical software, and also reads coded patient information into a worklist.

Figure 1-10 Typical barcode reader (example)

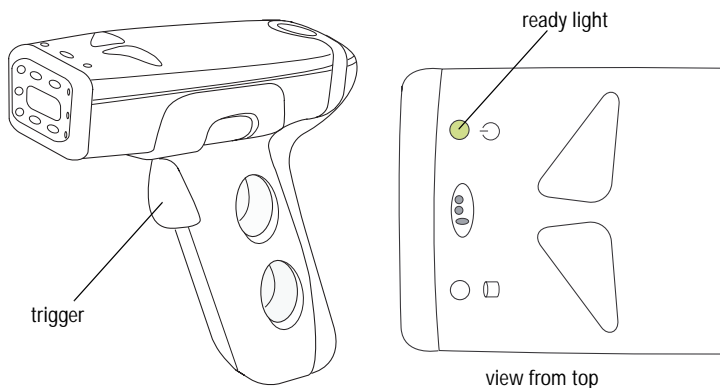

For information on installing and using the barcode reader with the BD FACSCanto II, see *Installing and Using the Barcode Reader* on page 46. For detailed information including how to program the barcode reader for other barcode standards, refer to the information supplied by the manufacturer.

System Requirements

Software

Both included software packages must be installed:

- BD FACSCanto II clinical software v2.1



Do not read FCS files created with v2.0 or v2.1 into previous versions of BD FACSCanto II clinical software. Previous versions will show incorrect results.

- BD FACSDiva software v5.0

Workstation

BD FACSCanto II workstation purchased through BD Biosciences

Compatible Tubes

- 12 x 75-mm polystyrene test tubes (BD Falcon™ tubes)
- 12 x 75-mm BD Trucount™ tubes
- BD FACS 7-color setup bead tubes

Bulk Fluids

- BD FACSDiv solution
- BD™ FACSClean solution
- BD FACST™ shutdown solution
- full-strength bleach (waste tank)

Fluids Required for External Cleaning

- BD FACSClean solution
- Deionized (DI) water

Setup Beads

BD FACS 7-color setup beads for use with BD FACSCanto clinical software

2

BD FACS Loader Option

This chapter contains the following information:

- Loader Components on page 34
- Using the Loader on page 36
- Maintaining the Loader on page 42

Loader Components

The Loader is mounted directly on the flow cytometer. The device includes a drive system, tube lifter mechanism, spindle, and optical sensors, all of which are attached to a sliding drawer. Two sliding doors enclose the drawer to protect you from moving parts during operation. Table 2-1 provides a brief description of Loader components.

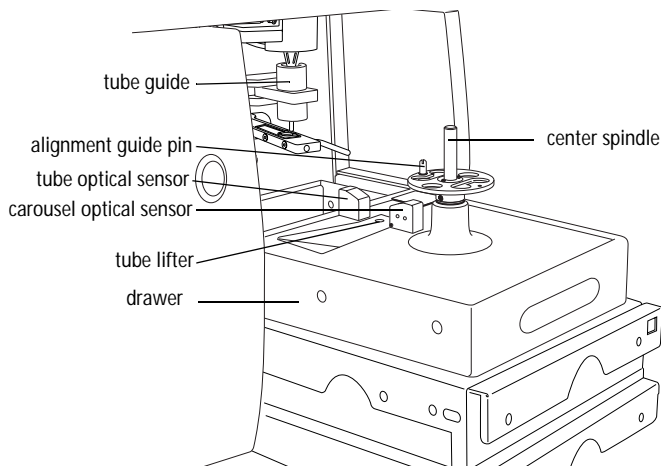

Table 2-1 Loader components

Component	Description
tube guide (with sensor)	guides tubes during lifting to ensure a proper seal (sensor indicates if tube guide is in position for Loader operation)
alignment guide pin	aligns the carousel and keeps it in place
carousel optical sensor	reads the carousel ID
tube optical sensor	scans the carousel to verify tube locations and match the associated worklist, and verifies a tube is in place before activating the tube lifter
tube lifter	a stainless steel rod that lifts the sample tube from the carousel to the sample injection tube (SIT)

Table 2-1 Loader components (continued)

Component	Description
drawer	holds the carousel; slides out for easy access
center spindle	the axis around which the carousel spins; insert the carousel onto the Loader here
drive system	the motor that rotates the carousel (not visible from exterior)

Carousel

The carousel accommodates up to forty 12 x 75-mm tubes. Each carousel has a unique ID printed on top and on an optically read label inside.

Figure 2-1 Sample-Prep Ready carousel

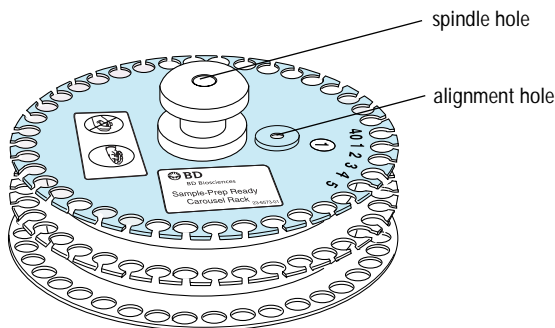

NOTICE The Loader is compatible only with the green-tinted carousels labeled “Sample-Prep Ready” (Figure 2-1).



Not all manufactured 12 x 75-mm tubes have been checked for proper functionality on the Loader. BD Biosciences has validated only disposable, 12 x 75-mm BD Falcon polystyrene test tubes, BD Trucount tubes, and BD FACS 7-color setup bead tubes.

Using the Loader

The Loader operates by software commands only. Commands are issued with either BD FACSCanto clinical software or BD FACSDiva software. For instructions on running samples with the Loader, refer to the *BD FACSCanto II Instructions for Use*.

Opening and Closing the Loader Doors

Sliding doors are located in front of and to the right of the Loader drawer.

Opening the Loader Doors

To open the front door, pull the top of its handle toward you (away from the cytometer) to disengage the latch, and then slide the door to the left. To open the right door, use its handle to slide the door away from you (toward the back of the cytometer).

Figure 2-2 Opening the Loader doors

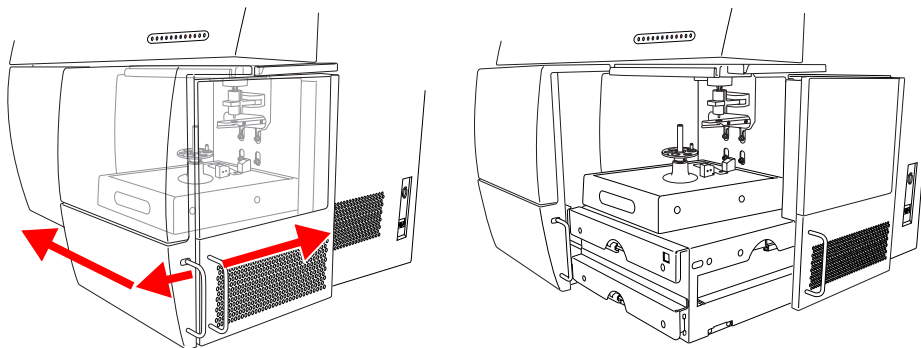

Closing the Loader Doors

To close the front door, use the handle to slide the door to the right until it latches. To close the right door, use the handle to slide the door toward the front until you feel it seat in the closed position. When both doors become properly closed, the Loader carousel spins as it initializes.

Acquiring with the Loader

This section explains how to set up the cytometer for acquisition with the Loader.

- 1 Verify that the cytometer is set up for automatic loading.

The tube guide should be forward, and the aspirator arm bar should be horizontal and aimed to the front (toward the carousel).

Figure 2-3 Automatic loading setup

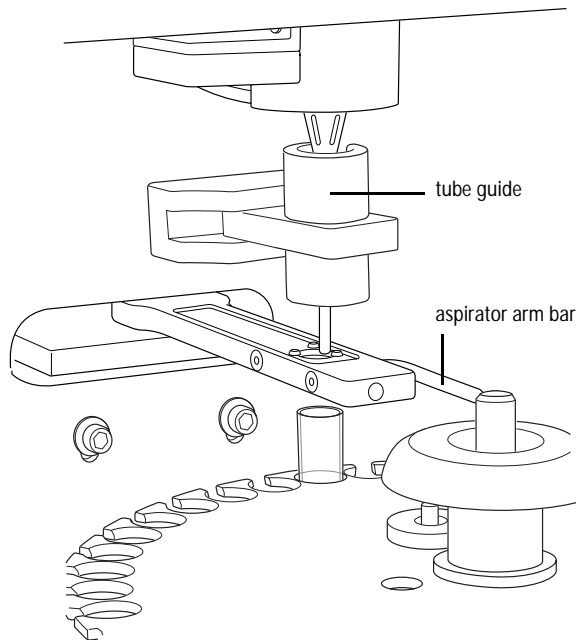

For detailed setup instructions, see [Changing to Automatic Loading](#) on page 41.

2 If needed, remove the carousel from the Loader:

- Slide the Loader doors open.
- Pull out the Loader drawer.
- Place your thumb on the center spindle, and press down with your thumb while gently pulling up on the carousel handle with two fingers, as shown.

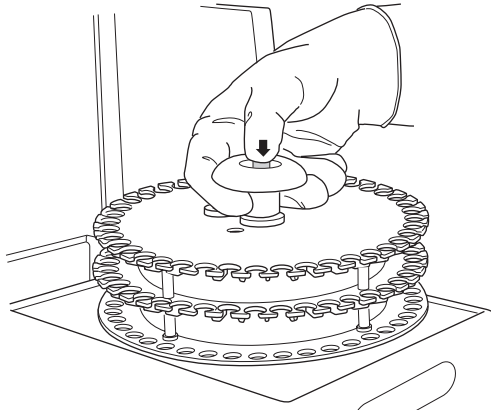

3 Vortex the sample tubes and place them uncapped in the carousel(s) according to the worklist.



For accurate results, match the tubes to those listed on the printed worklist (BD FACSCanto clinical software) or the Carousel Assignment tab (BD FACSDiva software). Print a copy of tube assignments and use the printout as a guide when filling each carousel.



To prevent binding during loading, make sure label thickness per tube is less than three labels. Flatten labels completely before placing a tube in the carousel.

4 Install the first carousel to be acquired on the Loader.

Position the spindle hole in the handle over the center spindle of the Loader drawer. Rotate the carousel until the alignment guide pin fits into the small alignment hole at the top of the carousel. Press down firmly to seat the carousel.

Figure 2-4 Seating the carousel in the Loader

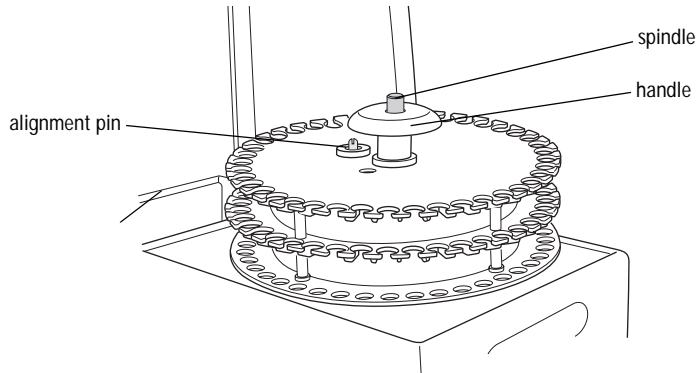

5 Close the Loader drawer completely, and close the Loader cover doors.

The Loader scans and positions the carousel at tube 1.



To run the Loader, the cover doors must be closed. Tubes will not be loaded if the cover doors are open. The currently running tube will be unloaded if the cover doors are opened during a run.

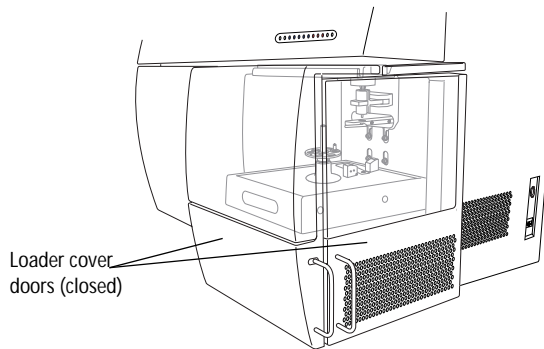



Changing Operational Modes

You can change the operational mode by performing a few simple steps. See the following sections for instructions.

- Changing to Manual Loading (on this page)
- Changing to Automatic Loading on page 41

Changing to Manual Loading

  Handle all biological specimens and materials as if capable of transmitting infection. Dispose of waste using proper precautions and in accordance with local regulations. Wear suitable protective clothing, eyewear, and gloves.

- 1 Open the Loader cover doors.
- 2 Pull out the drawer.
- 3 Remove any carousel in the Loader.
- 4 In manual mode, you do not need the tube guide arm. Move it all the way back and away from you.

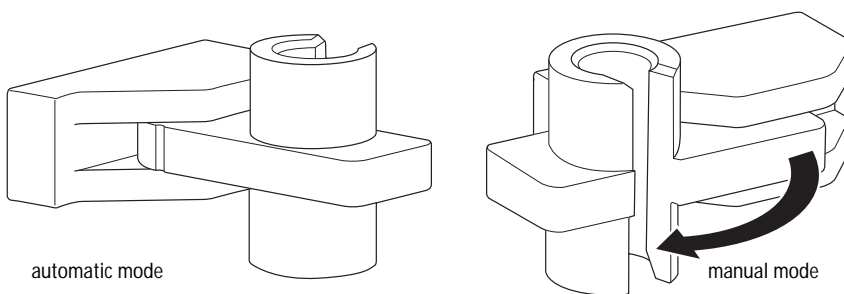

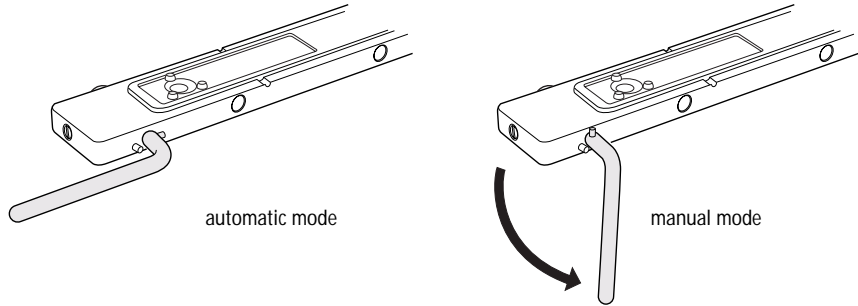

- 5 (Optional) Rotate the aspirator arm bar to the vertical (down) position. In this position, the bar can be used to move the aspirator arm to the side when manually loading a tube on the SIT.



You are ready to load tubes manually.

Changing to Automatic Loading

  Handle all biological specimens and materials as if capable of transmitting infection. Dispose of waste using proper precautions and in accordance with local regulations. Wear suitable protective clothing, eyewear, and gloves.

- 1 If the aspirator arm bar is not already in the forward position, rotate it to a horizontal position and aimed to the front (toward the carousel).

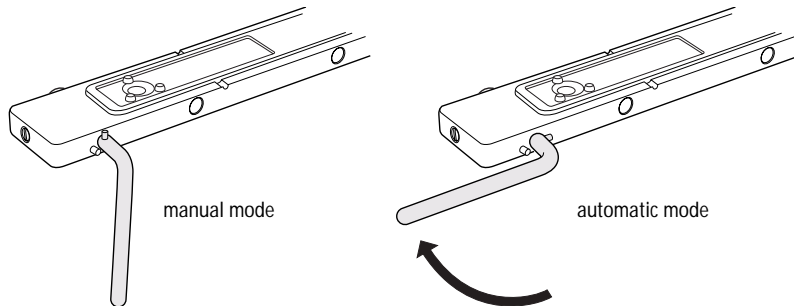

- 2 Move the tube guide arm all the way forward.

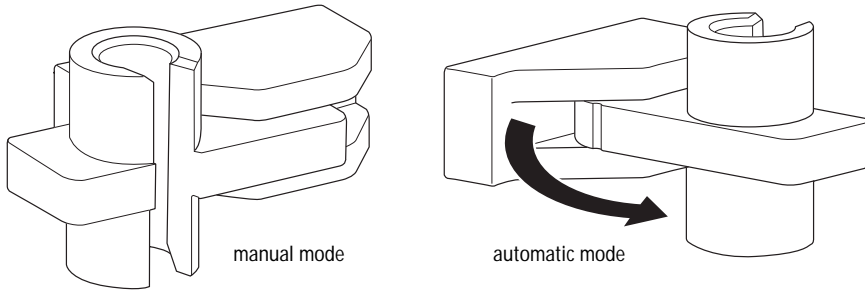

The tube guide arm is needed only when using the Loader.



You are ready to load tubes automatically.

Maintaining the Loader

This section explains the cleaning procedure you should follow to keep your Loader in good condition.

  All instrument surfaces that come in contact with biological specimens can transmit potentially fatal disease. Use universal precautions when cleaning instrument surfaces. Wear suitable protective clothing and gloves.

 To prevent damage, do not use isopropyl alcohol or ethanol on any Loader surfaces.

Spill Containment Area

The top of the Loader has a depressed area intended to contain spills that may occur during operation. Check this area for fluids and clean as described in the following section.

Cleaning External Surfaces

To keep the Loader free from salt buildup, wipe down all external surfaces that have been exposed to sheath fluid.

Materials

- BD FACSClean solution
- DI water
- clean, lint-free cloths or disposable wipes

Procedure



To avoid potential shock, always switch off the power and unplug the AC power cord before you begin cleaning.

- 1 Switch off the cytometer power and unplug the AC power cord from the wall socket.
- 2 Wipe all accessible surfaces with BD FACSClean solution.

Ensure that the optical sensors are cleaned. Saline deposits can develop on the sensors, causing tubes in the carousel to be missed.

- 3 Wet a fresh cloth with DI water and wipe all exposed surfaces to prevent corrosion.
- 4 Wipe all exposed surfaces with a clean, dry cloth.

3

Barcode Reader Option

This chapter contains the following information:

- Installing and Using the Barcode Reader on page 46
- Cleaning the Barcode Reader on page 48
- Barcode Symbologies on page 49

Installing and Using the Barcode Reader



To prevent laser injury, do not stare into the reader or aim it at another person's eyes while the trigger is depressed.

NOTICE The Opticon LG2 Imager2D barcode reader available for the BD FACSCanto II is capable of reading both 1D and 2D barcode symbologies. See Barcode Symbologies on page 49.

The BD FACSCanto II system supports only two uses of the 2D barcode reader:

- reading information from the BD FACS 7-color setup beads label into BD FACSCanto clinical software (2D barcode symbology)
- reading coded patient information from sample tube labels into a worklist (1D barcode symbology)

NOTICE The barcode reader supplied with the BD FACS™ Sample Prep Assistant II (SPA II) is a 1D reader that cannot read information from BD FACS 7-color setup beads. Use only the Opticon LG2 Imager 2D barcode reader for reading information from the BD FACS 7-color setup beads label into BD FACSCanto clinical software.

NOTICE Contact BD Biosciences before changing default barcode settings.

- 1 Plug the barcode reader into the USB port on the back of your computer.
The reader turns on automatically.
- 2 Make sure the green light on top of the reader is illuminated:

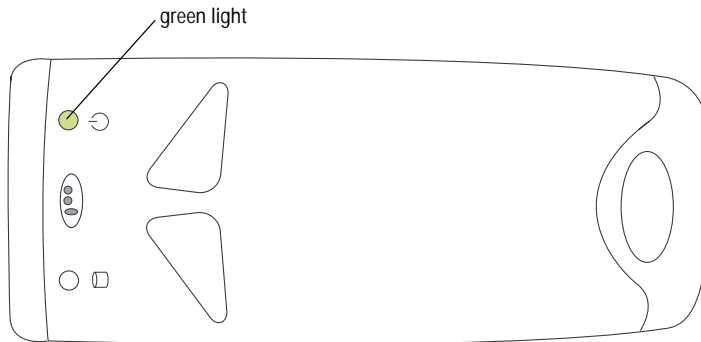

- 3 In BD FACSCanto clinical software, navigate to the fields for which information can be scanned.
 - Lot information for BD FACS 7-color setup beads is scanned into the Setup Lot Information dialog from the setup values label supplied with the setup bead kit (NOT from the lot number on the setup bead tubes).
 - Patient information is scanned from sample labels into the worklist ID field.
- 4 Locate the barcode on the setup values label of BD FACS 7-color setup beads kit, or on the patient sample.



For accurate results, do not photocopy or enlarge the barcodes that are included with the reagent. Scan the barcodes exactly as they are provided.

- Tip** To make it easier to use, an optional stand is available for the barcode reader. See Bar Code Reader Parts on page 141.

- 5 Aim the barcode reader at the center of the barcode. The barcode reader has two focal lengths, 10 cm and 23 cm (4 in. and 9 in.):
 - For reading BD FACS 7-color setup bead labels, hold the barcode reader 23 cm (9 in.) from the labels.
 - For reading patient information from sample tube labels, hold the barcode reader 10 cm (4 in.) from the labels.
- 6 Press and hold the trigger on the barcode reader until you hear a beep.

If the reader does not beep, adjust your distance from the barcode while continuing to hold the trigger.
- Tip** To obtain a reading, keep the bar code reader aimed at the center of the label. Do NOT sweep across the label.
- 7 Compare software field values with the setup beads or sample label.

Cleaning the Barcode Reader



To prevent laser injury, do not stare into the reader or aim it at another person's eyes while the trigger is depressed.

For best performance, keep the front window of the barcode reader clean. Do not touch the window directly, and wipe it only with a soft, non-abrasive cloth moistened with one of the following:

- isopropyl alcohol
- ethyl alcohol (denatured grade)



Do not use BD FACSClean solution (or bleach) to clean or disinfect the barcode reader.

Barcode Symbologies

Although data entry using barcodes is generally more reliable than manual data entry, it is not guaranteed to be 100% accurate. To increase accuracy when using the barcode reader, enabling checksums is recommended.



Using barcode symbologies without checksums increases the likelihood of incorrect information transfer, including sample ID assignments. This can result in a mismatch of sample IDs and sample results.

By default, the barcode reader has checksums enabled. We recommend you do not disable checksums, or use barcode symbologies without checksums.

1D Barcode Symbologies

BD Biosciences has evaluated the following 1D barcode symbologies for use with the BD FACSCanto II flow cytometer, and has these recommendations:

Barcode Symbology	Recommendation
Code 128	Preferred.
Code 39	Acceptable if barcode labels are printed with the checksum digit. By default, the barcode reader recognizes the checksum digit when reading the Code 39 symbology. However, if labels are printed without a checksum digit, contact your BD service representative for instructions on disabling the checksum feature.
Codabar	The barcode reader does not support the checksum feature when reading the Codabar symbology.

2D Barcode Symbologies

BD Biosciences has evaluated 2D barcode symbology to read the target values of BD FACS 7-color setup beads when using BD FACSCanto clinical software. 2D barcode symbology is required to read all target values with one scan.

For information on installing and using the barcode reader with the BD FACSCanto II system, see *Installing and Using the Barcode Reader* on page 46. For detailed information including how to program the barcode reader for other barcode standards, refer to the information supplied by the manufacturer.

4

Maintenance

The BD FACSCanto II system requires basic preventive maintenance to preserve instrument reliability. This section explains the procedures you should follow to keep your instrument in good condition.

- Scheduled Maintenance on page 52
- Unscheduled Maintenance on page 66



Scheduled Maintenance

For optimal instrument functioning, perform the following maintenance according to the recommended schedule.

Procedure	Description and Location	Frequency
Fluidics startup	Replaces BD FACS shutdown solution with BD FACSFlow solution Refer to <i>BD FACSCanto II Instructions for Use</i> .	Daily
Fluidics shutdown	Replaces BD FACSFlow solution with BD FACS shutdown solution Refer to <i>BD FACSCanto II Instructions for Use</i> .	Daily
Empty the waste	See Emptying the Waste Container on page 54.	Daily and as needed
Wipe down SIT and aspirator arm	Prevents saline deposit buildup Refer to the <i>BD FACSCanto II Instructions for Use</i> .	Daily
Empty the condensation trap on the fluidics cart	Prevents overflow of condensation trap Refer to the <i>BD FACSCanto II Instructions for Use</i> .	Daily
Purge fluid filters	Removes air from fluid filters, ensuring they will not dry out See Purging the Fluidics Filters on page 57.	Weekly
Change the waste tank cap	See step 6 on page 56.	Monthly

Procedure	Description and Location	Frequency
Decontaminate fluidics (Long Clean)	Decontaminates the internal sheath path with BD FACSClean solution, then rinses with BD FACS shutdown solution See Decontaminating the Fluidics System (Long Clean) on page 59.	Monthly and before service calls
Replace the air filter	Ensures proper instrument performance See Replacing the Air Filter on page 60.	Every 6 months
Replace fluid filters	Keeps fluids free of particulates See Replacing Fluidics Filters on page 63.	Every 6 months or when increased debris observed in FSC vs SSC plots
Schedule preventative maintenance by BD service	—	Every 6 months

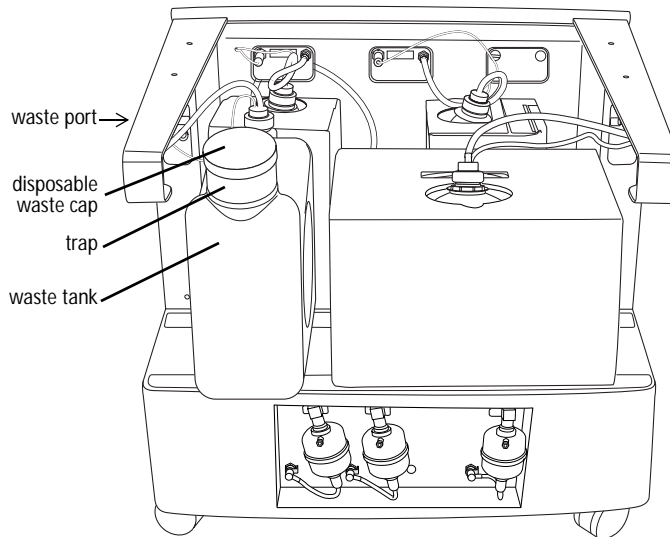

Emptying the Waste Container

  All biological specimens and materials coming into contact with them can transmit potentially fatal disease. To prevent exposure to biohazardous agents, expose waste container contents to bleach (10% of total volume) before disposal. Dispose of waste in accordance with local regulations. Use proper precaution and wear suitable protective clothing, eyewear, and gloves.



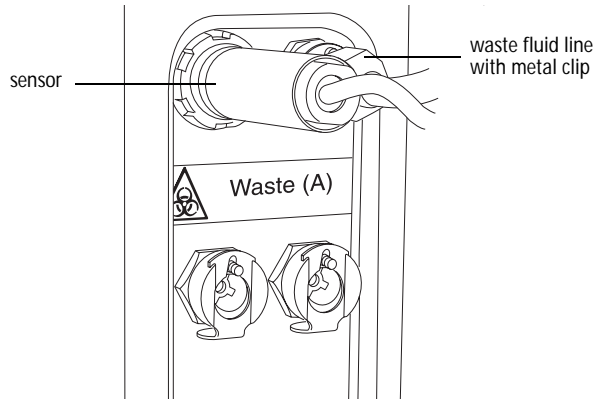

- 1 Ensure the cytometer is not acquiring events.
- 2 Detach the waste container's sensor and fluid line from the fluidics cart waste port.
 - Pull the sensor straight out.
 - Press the metal clip on the fluid line.



  The waste tank can become pressurized when the cytometer is running. Always disconnect the tank from the fluidics cart before you empty it. Wait at least 30 seconds for pressure to dissipate before you remove the waste cap or level sensor cap.

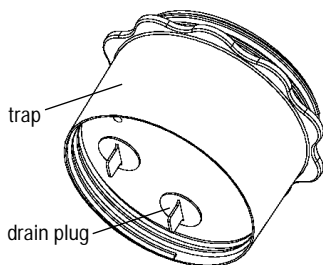

- 3 Remove the disposable waste cap and attached trap from the container; place the assembly on the bench label-side up.

  Do not wet the cap. If you see liquid inside the trap, remove the drain plug and fully drain the liquid before you replace the plug.

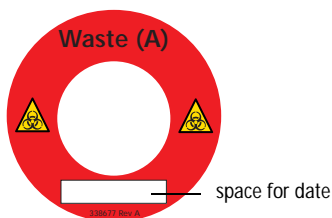

- 4 Empty the bleach-exposed waste.
- 5 Add approximately 1 L of bleach to the empty waste container (10 L container).
- 6 If one month has passed since the last cap change:
 - Detach the cap from the trap.
 - Replace it with a new cap.
 - Write the date on the cap label.



  To prevent tank overpressurization, do not overtighten the trap or attached filter cap. Tighten each component only until it is hand-tight. Do not use sealants such as Teflon® tape or other adhesives.

- 7 Screw the cap assembly onto the tank and hand-tighten until it is fully closed.
- 8 Re-attach the sensor and fluid lines.

Purging the Fluidics Filters

Once a week, purge air from all fluid filters by opening the bleeder valve on the top of each filter, one at a time. This ensures that the filters will not dry out. Prime fluid lines before purging the filters, as noted in the procedure.

NOTICE The cytometer must be on (system pressurized) during this procedure.

Materials

- paper towels
- proper protective equipment

Procedure

- 1** Run the Prime After Tank Refill for all fluids to ensure all fluid lines are primed.

See Priming Fluidics Lines on page 71.

- 2** Place a few paper towels beneath the filter to be purged to absorb any fluid leakage.

- 3 Loosen the bleeder valve near the top of the filter by turning it counterclockwise.

NOTICE Do not loosen the bottom bleeder valve. Ensure it is tightened.

- Tip** Do not completely unscrew the valve. If you do, it will come off.

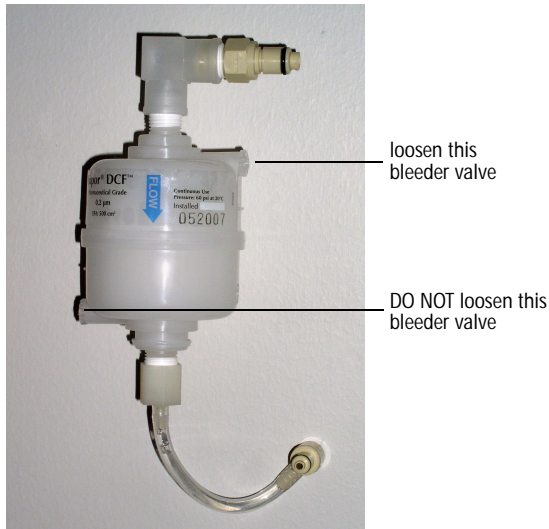

- 4 Wait until fluid seeps out.

Fluid should seep from the open valve within 30 seconds. If no fluid appears, make sure the corresponding cubitainer is not empty or detached from the cart. If the cubitainer contains fluid and the fluid lines are attached and primed, the filter might be airlocked. See *Removing an Air Lock* on page 72.

- 5 Close the valve by turning it clockwise.
- 6 Repeat steps 2 through 5 with the remaining filters.

Decontaminating the Fluidics System (Long Clean)

Use the Long Clean command to decontaminate the internal sheath path with BD FACSClean solution. After decontamination, the lines are rinsed with BD FACS shutdown solution.

NOTICE This procedure takes about 75 minutes to complete.

Materials

- undiluted bleach (for waste tank)
- BD FACSClean solution (approximately 275 mL)
- BD FACS shutdown solution (approximately 1,100 mL)

Procedure



The Cytometer menu in BD FACSCanto clinical software differs slightly from the BD FACSDiva Instrument menu. Instructions in this and following sections list the BD FACSCanto II menu first, followed by the BD FACSDiva menu, in parentheses.

- 1 Check all fluid levels. Empty the waste if needed.
- 2 Select Cytometer (Instrument) > Cleaning Modes > Long Clean.

A confirmation dialog is displayed.

- 3 Click OK to continue. Once you have begun the Long Clean, you cannot abort the process.

A completion message displays when the cleaning cycle finishes.

Figure 4-1 Long Clean completion message

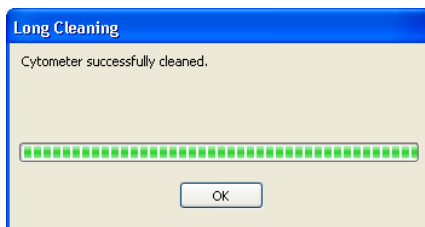

BD FACSCanto clinical software

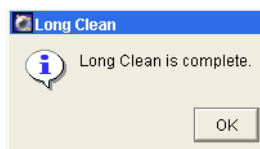

BD FACSDiva software

4 Click OK.



If the completion message has not displayed after 90 minutes, verify there are no error messages in the Status tab of the Instrument frame. If the cleaning mode fails, see *Fluidics Cart Troubleshooting* on page 101.

5 Choose to shut down or continue.

- To shut down, quit the software and turn off the power to the cytometer.
- To continue, select Cytometer (Instrument) > Fluidics Startup.

BD FACS shutdown solution can lyse cells. The Fluidics Startup procedure removes BD FACS shutdown solution from the interior reservoir and fluid lines and replaces it with BD FACSFlow solution.

Tip If setup fails after a long clean, repeat Fluidics Startup until setup passes.

Replacing the Air Filter

The BD FACSCanto II instrument has an air filter located in the side door. Replace the filter every 6 months to ensure proper instrument performance.

Materials

replacement filter (see Other Replacement Parts on page 141 for ordering)

Procedure

- 1 Turn off the cytometer power.
- 2 Open the side door:
 - Press the black button—a handle will pop out.



- Twist the handle and pull.



- 3 On the door's interior, turn the tabs located along the upper edge of the filter to release the old filter.

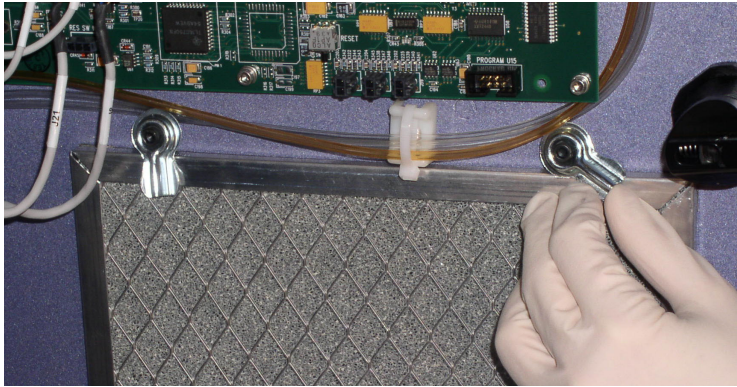

Dispose of the old filter. It cannot be reused.

- 4 Install a new filter. Ensure that the arrows etched on edges of the new filter point in toward the instrument (arrows indicate direction of air flow).

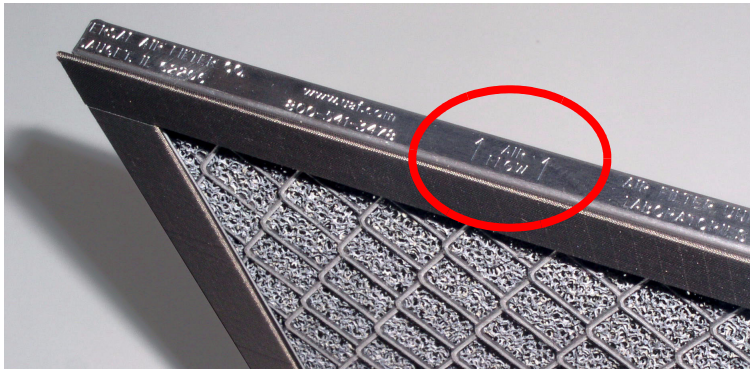

- 5 Turn the tabs to hold the filter in place.

- 6 Close the side door:
 - Twist the handle while closing door.
 - Push door closed until the door latches.
 - Push the handle in to latch the handle.

 To avoid instrument damage, do not close the door on any tubing or wires.

Replacing Fluidics Filters

Change the fluid filters when you see increased debris in FSC vs SSC plots, or every 6 months.



Materials

- replacement filter(s)—see Installation Kit on page 140 for ordering
- paper towels
- proper protective equipment
- felt tip pen

Procedure

- 1 Place a few paper towels beneath the filter to collect drips.
- 2 Remove the filter by pressing the tabs on each quick-disconnect coupling.

Figure 4-2 Removing the filter

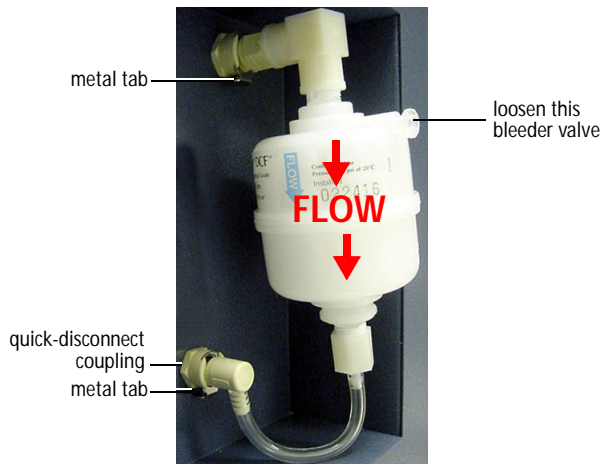

3 Position the new filter and connect the couplings.

☑ Tip Write today's date on the filter so you will know when to replace it.

4 Loosen the top bleeder valve by turning it counterclockwise.

NOTICE Do not loosen the bottom bleeder valve. Ensure it is tightened.

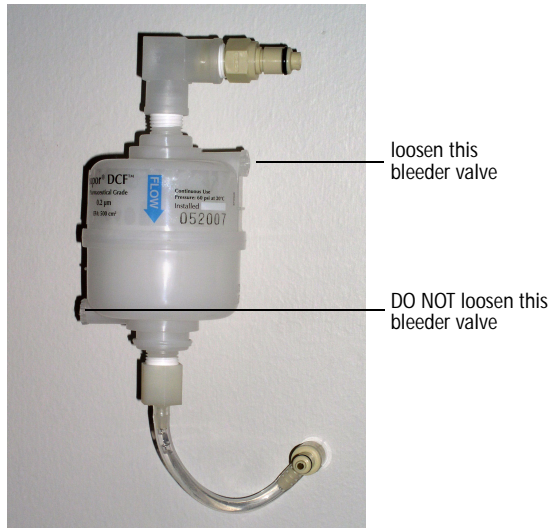

5 Wait until fluid seeps out.

Fluid should seep from the open valve within 30 seconds. If no fluid appears, ensure the corresponding cubitainer is not empty or detached from the cart. If the cubitainer contains fluid and the fluid lines are attached and primed, the filter might be airlocked. See Removing an Air Lock on page 72.

6 Close the valve by turning it clockwise.

Repeat the procedure for other fluid filters to be replaced.

Unscheduled Maintenance

Perform these maintenance procedures as indicated in the table.

Procedure	Description and Location	When to Perform
Replace cubitainers	See Changing a Cubitainer on page 68.	As needed
Prime fluid lines	Removes air from fluid lines See Priming Fluidics Lines on page 71.	Whenever a fluidics line is disconnected to change a cubitainer or perform other maintenance
Remove an air lock	Removes air from filter and restores flow of fluid See Removing an Air Lock on page 72.	When fluidics are not functioning properly (flow cell will not fill, or there is backflush into sample tube)
Clean external surfaces	Keeps surfaces free from salt buildup after exposure to sheath fluid See Cleaning External Surfaces on page 74.	As needed
De-gas Flow Cell	Removes bubbles from the flow cell See See Removing Bubbles from the Flow Cell on page 76.	As needed during daily startup
Clean Flow Cell	Runs BD FACSClean solution through the SIT and flow cell See Cleaning the Flow Cell on page 76.	When poor optical performance indicates additional cleaning is needed
Bubble Filter Purge	Removes air from the bubble filter See Purging the Bubble Filter on page 78.	If fluidics run dry, or when CVs are poor

Procedure	Description and Location	When to Perform
Decontaminate the fluidics system for storage	Cleans out the fluidics lines with BD FACSClean solution, then fills them with BD FACS shutdown solution See Decontaminating the Fluidics System for Storage on page 79.	Before long-term storage
Replace the Bal seal	Replaces worn Bal seal See Replacing the Bal Seal on page 79.	When the seal becomes worn or cracked (sample tubes will not pressurize)
Reset the cytometer circuit breaker	See Resetting the Cytometer Circuit Breaker on page 85.	After the circuit breaker is tripped
Reattach Ethernet and RS232 cables	See Reconnecting the Ethernet and RS232 Cables on page 86.	When a cable is disconnected
Reconnect fluidics cart tubing	See Reconnecting the Fluidics Cart Tubing on page 86.	As needed
Replace fluidics level sensors	See Replacing the Fluidics Level Sensors on page 89.	When instructed to by a BD Biosciences service representative
Replace fluidics cart fuses	See Replacing the Fluidics Cart Fuses on page 92.	When cart will not function because of power surge or other electrical event

Changing a Cubitainer

Three fluidics cubitainers (disposable boxes of approved fluids) and a waste container fit onto the cart in the following configuration:

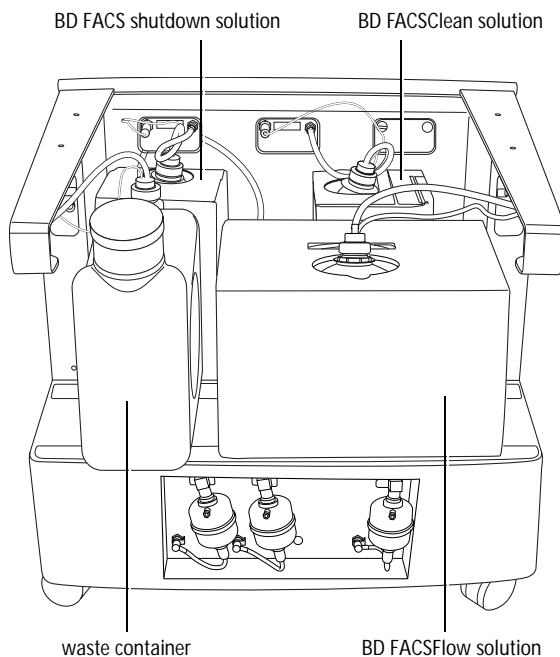

Each cubitainer and the waste tank has its own color-coded port. Connect containers to the following ports:

Container	Port Label	Port Color
waste	Waste (A)	orange
BD FACSFlow solution	BD FACSFlow	blue
BD FACS shutdown solution	BD FACS Shutdown Solution	yellow
BD FACSClean solution	BD FACSClean Solution	yellow

Procedure

- 1 Ensure the cytometer is not acquiring events.
- 2 Detach the sensor and fluid line from the cart.
 - Pull the sensor straight out.

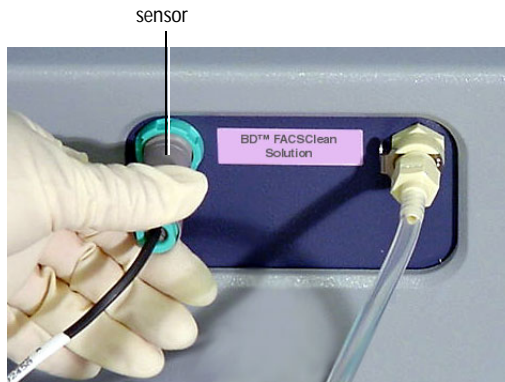

- Press the metal clip on the fluid line.

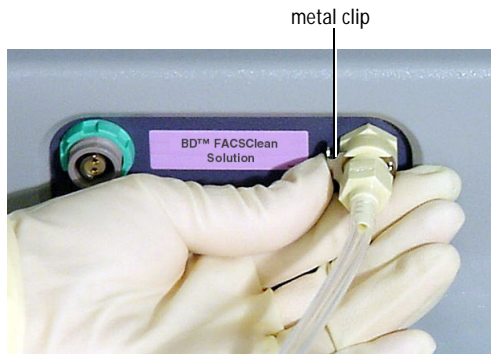

 You could damage the sensor line if you leave it connected while changing a cubitainer.

- 3 Unscrew the cap on the cubitainer.

- 4 Remove the cap and sensor assembly and set it aside.

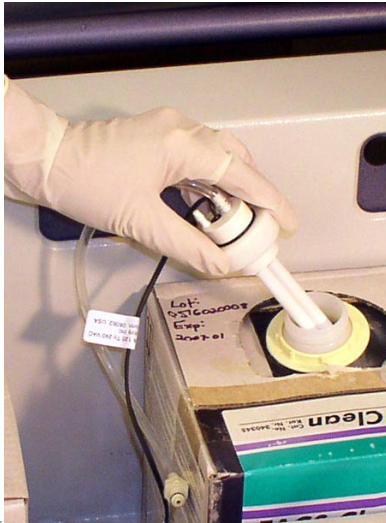

- 5 Put a new cubitainer onto the fluidics cart.
- 6 Replace the cap assembly and hand-tighten it until it is fully closed.
- 7 Reattach the sensor line and fluid line to the cart.
 - To attach the sensor line, gently rotate until the connection aligns, and then push.
 - To attach the fluid line, push the coupling into the port until it clicks.



To ensure that the appropriate solutions are dispensed, match the label on the container to the port on the fluidics cart.

- 8 Prime the fluidics.

Important: Continue with the procedure in Priming Fluidics Lines on page 71.

Priming Fluidics Lines

Use the Prime After Tank Refill command to remove air from the fluidics lines after you change a cubitainer or detach the fluidics lines for other maintenance.

- 1 Choose Cytometer (Instrument) > Cleaning Modes > Prime After Tank Refill.
- 2 Select the checkboxes for the cubitainers you changed; click OK.



BD FACSCanto clinical software

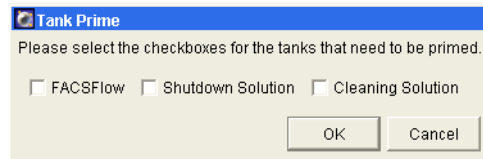

BD FACSDiva software

- 3 Click OK when the completion message displays.

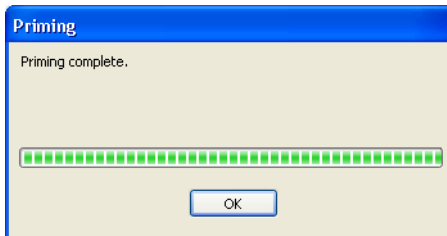

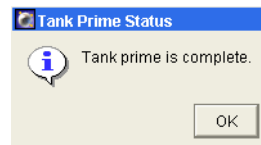

BD FACSCanto clinical software



BD FACSDiva software

Removing an Air Lock

If too much air gets into the sheath filter, it becomes impermeable to fluid and an air lock can develop. Although it is most likely to occur in the sheath filter, an air lock can develop in any of the fluidics filters.

  All instrument surfaces that come in contact with biological specimens can transmit potentially fatal disease. Use universal precautions when cleaning instrument surfaces. Wear suitable protective clothing and gloves.

Materials

- paper towels
- bypass tubing

Procedure

- 1 Place a few paper towels beneath the air-locked filter to collect drips.
- 2 Remove the filter by pressing the metal tabs.

Figure 4-3 Removing a filter



3 Install bypass tubing in place of the filter.

Push the tubing into each quick-disconnect port until you hear a click.

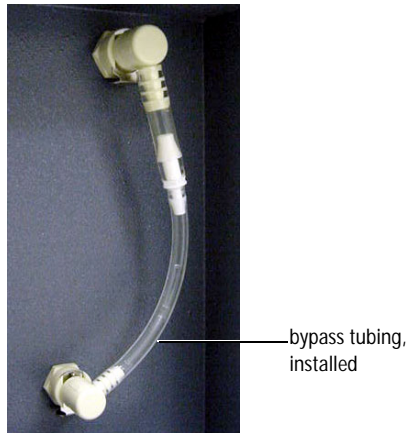

4 Choose Cytometer (Instrument) > Cleaning Modes > Prime After Tank Refill.

5 Select the checkbox that corresponds to the filter you have bypassed.

6 Click OK.



BD FACSCanto clinical software

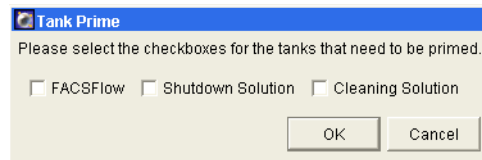

BD FACSDiva software

7 When the prime finishes, remove the bypass tubing.

8 Reattach the filter to the fluidics cart.

- 9 Repeat the Prime After Tank Refill command.
- 10 Open the bleeder valve and wait for fluid to seep out. Close the valve.
If no fluid seeps out, repeat steps 9 and 10.

Figure 4-4 Bleeder valve

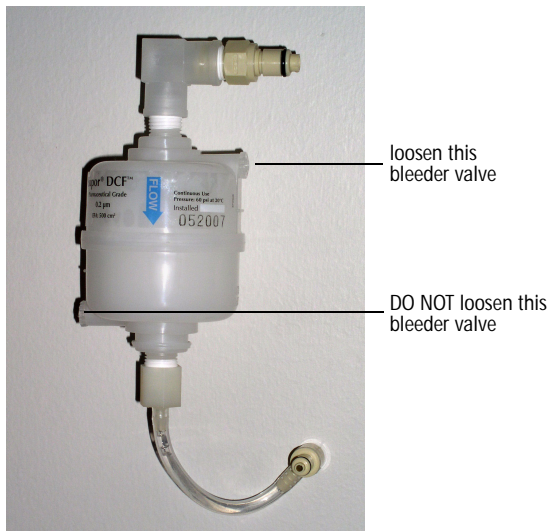



Cleaning External Surfaces

To prevent saline deposit buildup, wipe down all external instrument surfaces that have been exposed to sheath fluid.

NOTICE Over time, saline deposits may develop on the interior surface of the SIT Bal seal retainer, causing an incomplete SIT flush between samples. If this occurs, you might need to remove and clean the retainer with DI water. See Figure 4-5 on page 80 and steps 3, 4, 9, and 10 of the Replacing the Bal Seal procedure that starts on page 79.

NOTICE Do not use BD FACSClean solution or bleach to clean or disinfect the barcode reader. See Cleaning the Barcode Reader on page 48.

  All instrument surfaces that come in contact with biological specimens can transmit potentially fatal disease. Use universal precautions when cleaning instrument surfaces. Wear suitable protective clothing and gloves.



 To prevent damage, do not use isopropyl alcohol or ethanol on any cytometer or fluidics cart surface.

Materials

- BD FACSClean solution
- DI water
- clean, lint-free cloths or disposable wipe

Procedure

- 1 Switch off the cytometer power and unplug the AC power cord.

  To avoid potential shock, always switch off the power and unplug the AC power cord before you begin cleaning.

- 2 Wipe all accessible surfaces with BD FACSClean solution.
- 3 Wet a fresh cloth with DI water and wipe all bleach-exposed surfaces to prevent corrosion.
- 4 Wipe all exposed surfaces with a clean, dry cloth.

Removing Bubbles from the Flow Cell

Use the De-gas Flow Cell command to remove bubbles from the flow cell.

- 1 Select Cytometer (Instrument) > Cleaning Modes > De-gas Flow Cell.
- 2 Click OK when the completion message displays.

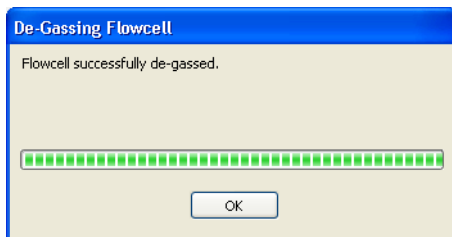

BD FACSCanto clinical software

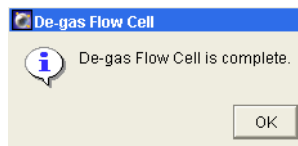

BD FACSDiva software

- 3 Check the flow cell for bubbles.

If you still see bubbles, repeat the process.

Cleaning the Flow Cell

Use the Clean Flow Cell command to run a tube of BD FACSClean solution through the SIT and flow cell. After the procedure is complete, the cleaning fluid remains in the SIT and flow cell until you run fluidics startup or shutdown. Perform this procedure when poor optical performance indicates that additional cleaning is needed.

Materials

- 2 mL of BD FACSClean solution
- one 12 x 75-mm polystyrene test tube (BD Falcon tube)

Procedure

- 1 Choose Cytometer (Instrument) > Cleaning Modes > Clean Flow Cell.
- 2 If you have a Loader installed, remove the carousel.
- 3 When prompted, manually install a tube containing approximately 2 mL of cleaning solution onto the SIT, and click OK.

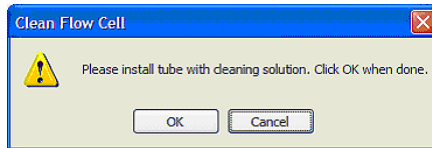

BD FACSCanto clinical software

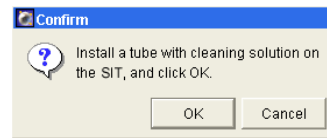

BD FACSDiva software

A progress message is displayed during the cleaning.

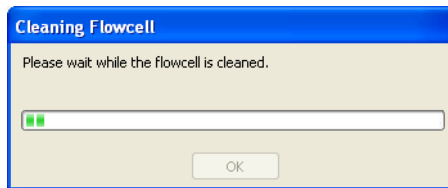

BD FACSCanto clinical software

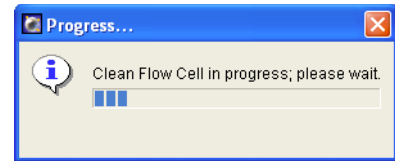

BD FACSDiva software

- 4 After the completion message displays, wait 5 minutes.

Waiting allows BD FACSClean solution to dissolve deposits in the flow cell cuvette.

- 5 Click OK.
- 6 Remove the tube from the SIT.
- 7 Clear BD FACSClean solution from the flow cell and fluidics lines:
 - Before running setup or samples, run Fluidics Startup.
 - To shut down without running more samples, run Fluidics Shutdown.

Purging the Bubble Filter

The bubble filter is situated between the plenum and the flow cell and ensures that the flow cell remains bubble-free. However, should the fluidics run dry, you might need to remove air from the bubble filter. Poor CVs might indicate a need to purge the bubble filter.

- 1 Start the bubble filter purge:
 - In BD FACSCanto clinical software, select Cytometer > Cleaning Modes > Bubble Filter Purge.
 - In BD FACSDiva software, select Instrument > Cleaning Modes > Bubble Filter Purge and Degas Flow Cell.
- 2 Wait while the purge finishes.

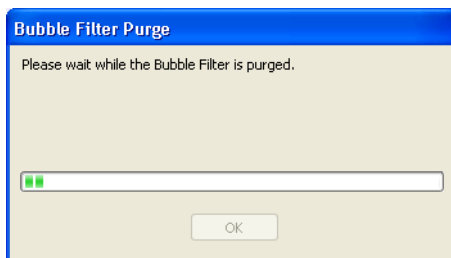

BD FACSCanto clinical software

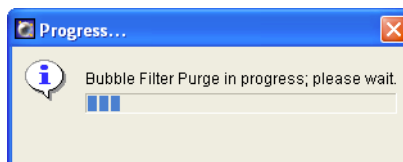

BD FACSDiva software

- 3 Click OK when the completion message displays.

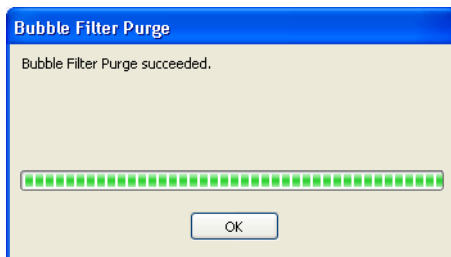

BD FACSCanto clinical software

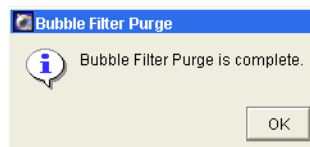

BD FACSDiva software

- 4 Repeat steps 1 through 3 until bubble-free liquid enters the flow cell from the bubble filter.
- 5 If you used BD FACSCanto clinical software in step 1, choose Cytometer > Cleaning Modes > De-gas Flow Cell.

Decontaminating the Fluidics System for Storage

If your cytometer is to be taken out of operation, perform the following procedure to clean out the fluidics lines and fill them with BD FACS shutdown solution.

- 1 Perform steps 1 through 4 in Decontaminating the Fluidics System (Long Clean) on page 59.
- 2 Shut down the software and turn off the power to the cytometer.
- 3 Wipe down the SIT and the aspirator arm with DI water.

Replacing the Bal Seal

The Bal seal is a Teflon ring that allows the sample tube to pressurize. Over time, this seal becomes worn or cracked and requires replacement. Replace the seal when persistent sample tube pressure errors occur.

Over time, saline deposits may develop on the interior surface of the SIT Bal seal retainer, causing an incomplete SIT flush between samples. Therefore, you should always rinse the retainer in DI water when you replace a Bal seal.

Figure 4-5 Bal seal and retainer

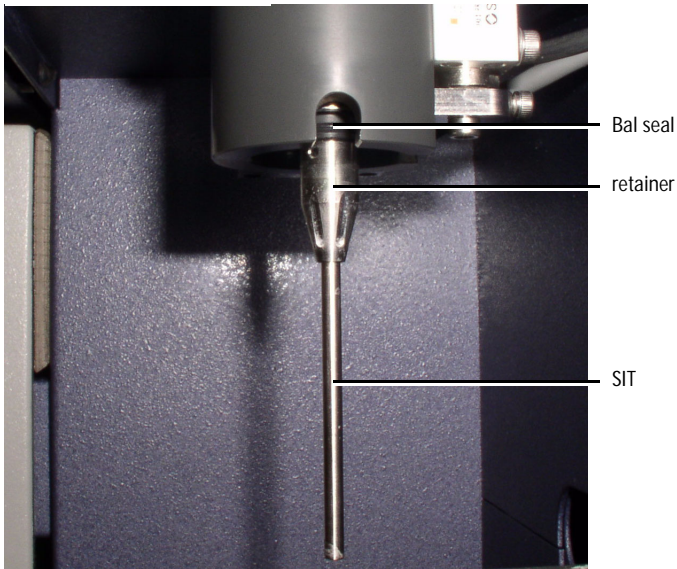

Materials

- proper protective equipment
- Bal seal removal tool



- replacement Bal seal
- DI water

Procedure

- 1 Turn off the cytometer.
- 2 If you have a Loader installed:
 - Open the Loader cover doors.
 - Pull out the drawer.
 - If needed, remove the carousel.
 - Move the tube guide to manual position. See Changing to Manual Loading on page 40.
- 3 Unscrew the retainer by turning it in the direction shown.

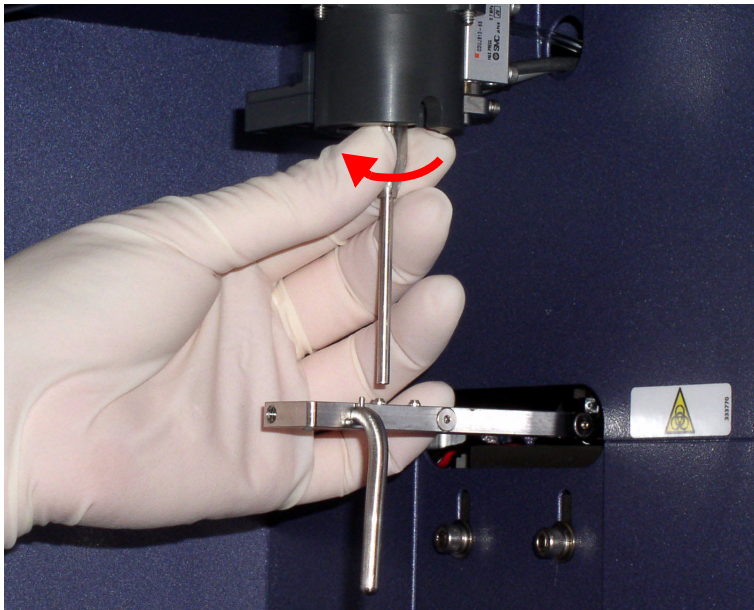

- 4 Lower the retainer down the SIT and let it rest on the aspirator arm.

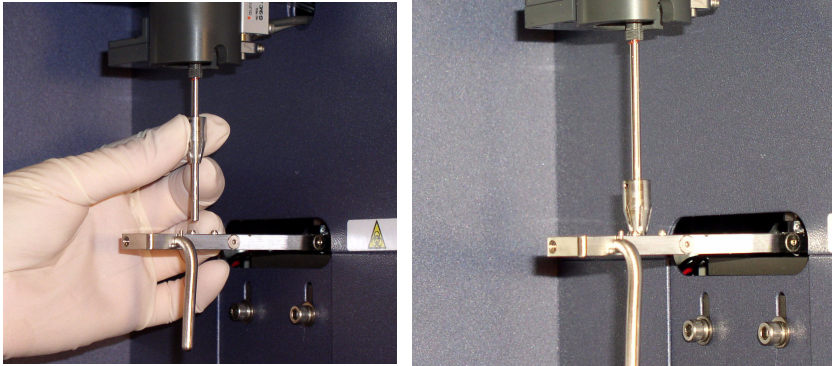

- 5 Access the Bal seal at the notch on the right side of the SIT assembly. Unseat the Bal seal by using the Bal seal removal tool to gently pull it downward.

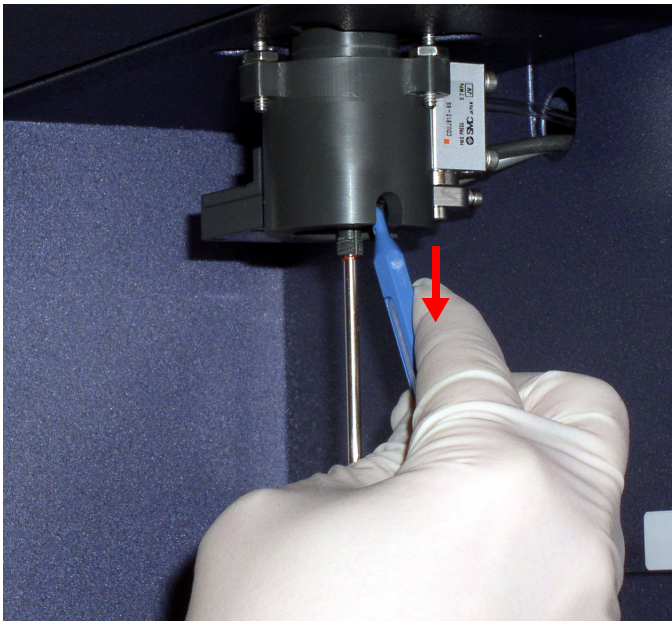

- 6 Allow the Bal seal to slide down the SIT and rest on top of the retainer.

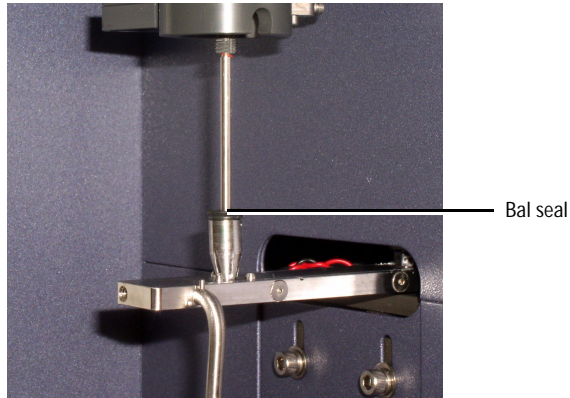

- 7 Center the Bal seal on the retainer. With one hand, support the retainer and Bal seal and with the other hand, move the aspirator arm to the left. Lower the retainer and Bal seal from the SIT.

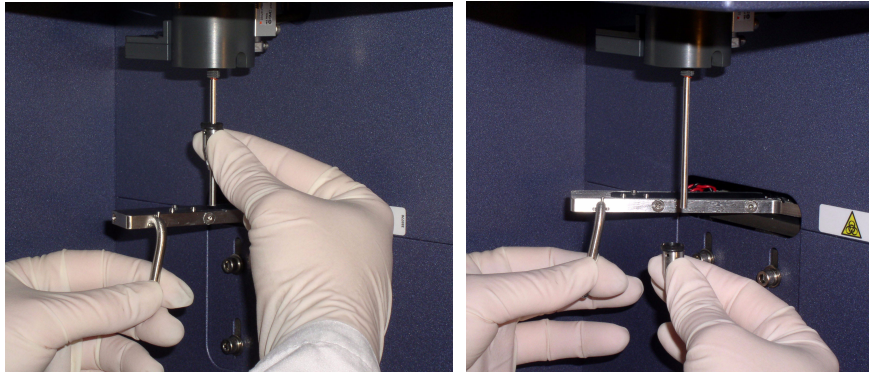

- 8 Hold the new Bal seal spring-side up (see figure), and slide it up the SIT. Use both hands to gently push it into its seated position.

- Tip** If the Bal seal is not quite in its seated position, replacing the retainer will seat it correctly.

Bal seal,
spring side up

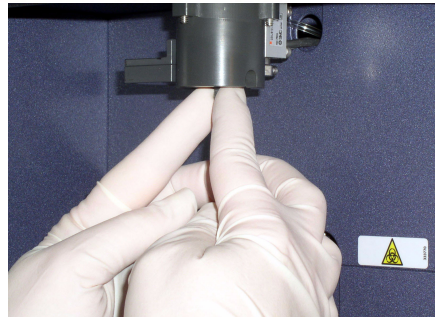
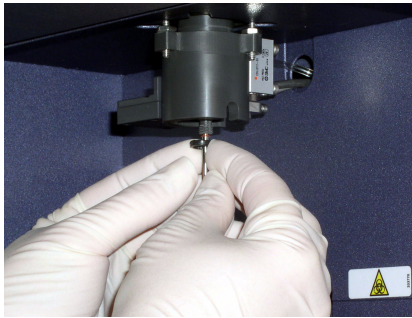

- 9 Rinse the retainer in DI water before replacing it on the SIT.
- 10 Reinstall the retainer over the SIT and tighten in the direction shown.

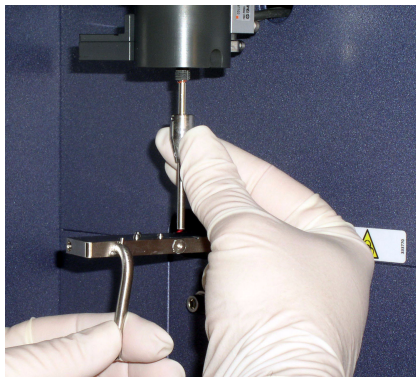

- 11 Test the installation by manually loading a tube onto the SIT and running fluid.
- 12 If you are using a Loader, ensure that the system is ready for automatic loading. See Changing to Automatic Loading on page 41.

Resetting the Cytometer Circuit Breaker

- 1 Toggle the cytometer circuit breaker switch to on.

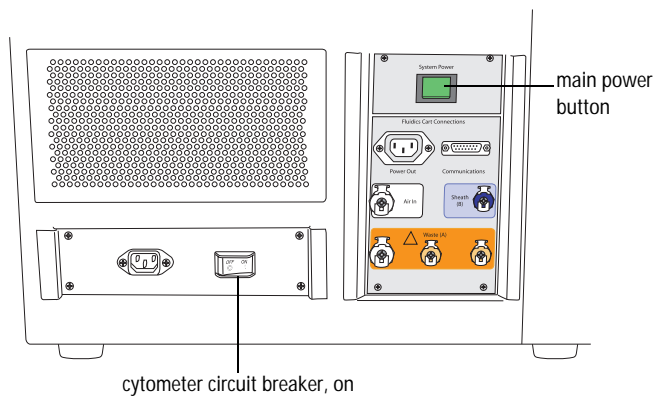

- 2 If it is off, turn on the cytometer main power.

Reconnecting the Ethernet and RS232 Cables

The cytometer connects to and communicates with the workstation through Ethernet and RS232 network cables. If these cables should become disconnected, use the following diagram to reconnect them.

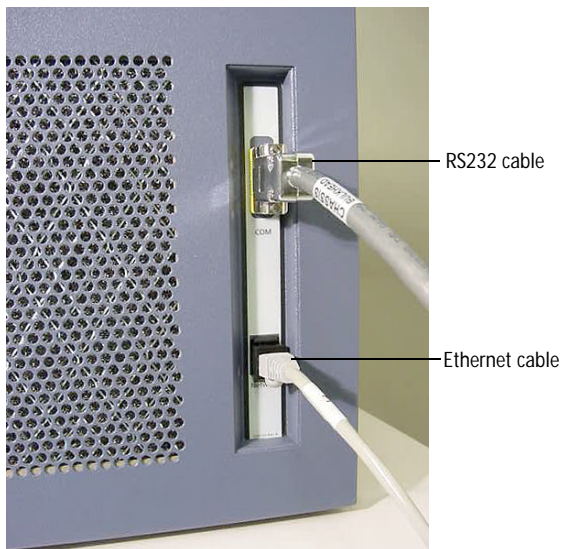

Both cables connect to ports on the PC workstation. As the make and model of the workstation might vary, refer to the documentation that came with your system for information.

Reconnecting the Fluidics Cart Tubing

Should any plugs, cords, or tubings become accidentally disconnected, use the following diagrams to reconnect the fluidics cart to the cytometer (Figure 4-6 on page 87).

- Tip** The ports and connectors are color coded.

Figure 4-6 Cytometer and fluidics cart ports

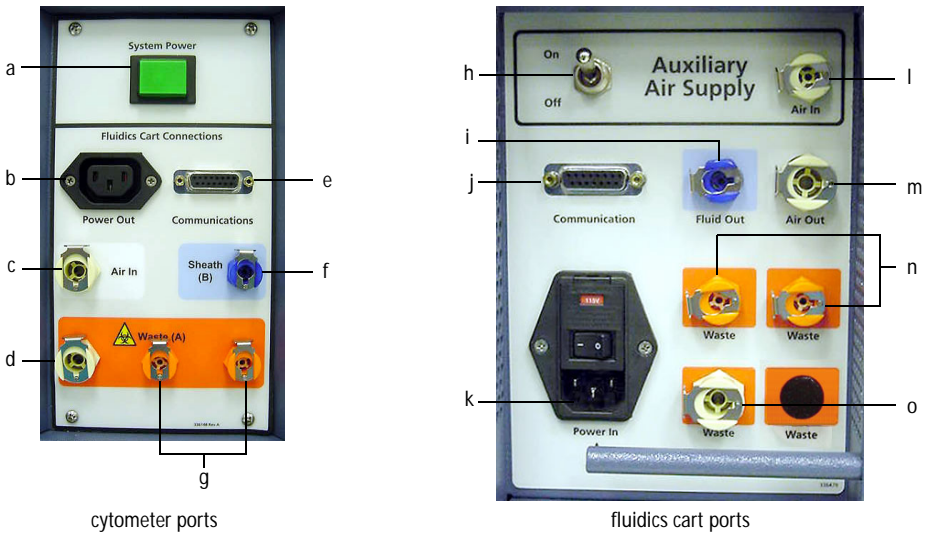

Cytometer ports and their corresponding fluidics cart ports are listed in Table 4-1. For example, ensure the tubing for *f. Sheath (B)* connects to the port labeled *i. Fluid Out*. See Table 4-2 on page 88 for port functions.

Table 4-1 Correspondence of cytometer ports to fluidics cart ports

Port or Button on Cytometer	Port on Fluidics Cart
a. System Power	—
b. Power Out	k. Power In
c. Air In	m. Air Out
d. Waste (A)	o. Waste
e. Communications	j. Communication
f. Sheath (B)	i. Fluid Out
g. Waste (A)	n. Waste
—	h. On/Off
—	l. Air In





  Do not plug the fluidics cart power cord into a wall outlet. Plug the cord into the cytometer only. This ensures proper electrical grounding and protects against electrical shock or damage to the instrument.



Table 4-2 Function of ports, buttons, and switches

Port or Switch	Additional Information
a. System Power	Powers both cytometer and fluidics cart
b. Power Out	Connects to fluidics cart
c. Air In	70±5 psi
d. Waste (A)	Waste out (aspirated)
e. Communications	Data port
f. Sheath (B)	BD FACSThrow solution port
g. Waste (A)	Waste out (non-aspirated)
h. On/Off	Auxiliary air supply switch. Keep in off position unless connected to house air.
i. Fluid Out	BD FACSThrow solution port
j. Communication	Data port
k. Power In	Connects to cytometer. Do not connect to wall outlet
l. Auxiliary Air In	There will be no tubing on this port unless connected to house air.
m. Air Out	Sends compressed air to cytometer
n. Waste	Waste in (non-aspirated)
o. Waste	Waste in (aspirated)

Replacing the Fluidics Level Sensors

Replace the fluidics level sensors when instructed to do so by a BD Biosciences service representative. Before you replace a sensor, try rinsing it with DI water.

  If you are changing the sensor on the waste tank, use proper precaution and wear suitable protective clothing, eyewear, and gloves. All biological specimens, and materials coming into contact with them, can transmit potentially fatal disease.

  The waste tank can become pressurized when the cytometer is running. Always disconnect the tank from the fluidics cart and wait at least 30 seconds for pressure to dissipate before you remove the level sensor cap.

Materials

- replacement fluidics sensor probe—see Other Replacement Parts on page 141 for ordering
- proper protective equipment

Procedure

- 1 Ensure that the cytometer is not acquiring events.
- 2 Detach the sensor and fluid line from the cart.
- 3 Unscrew the cap on the cubitainer.
- 4 Remove the level sensor assembly and discard into a suitable receptacle.

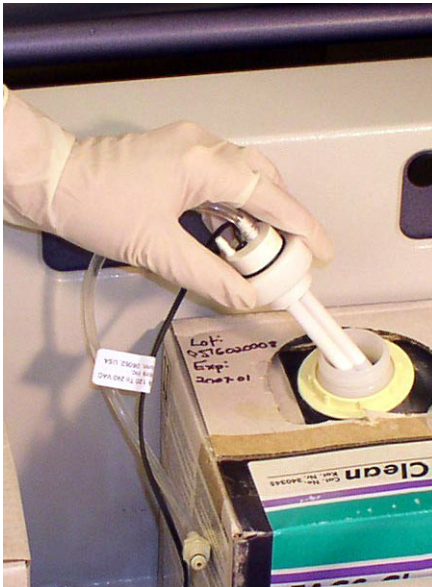

- 5 Put a new level sensor assembly on the cubitainer or tank. Hand-tighten the cap until it is fully closed.

Ensure use of the correct assembly (Figure 4-7).

Figure 4-7 Level sensor assemblies

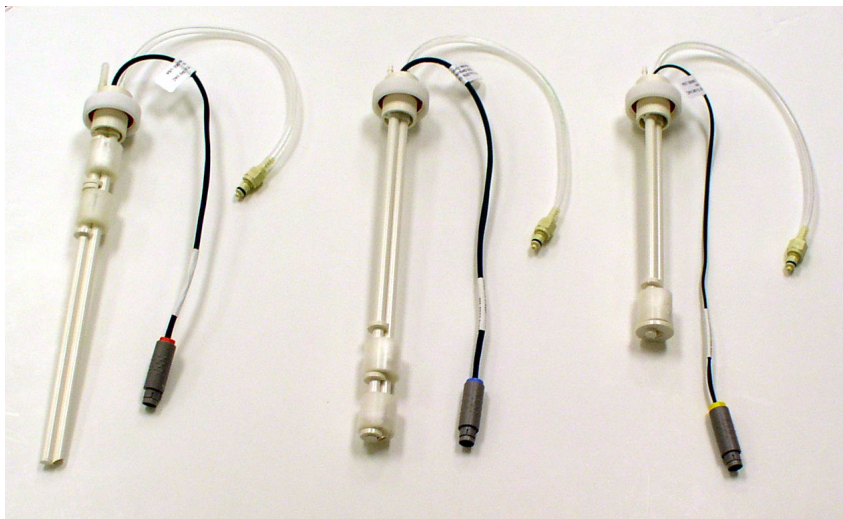

waste level sensor
(red connector)

BD FACSTow level sensor
(blue connector)

BD FACSClean solution and
BD FACS shutdown solution
level sensor (yellow connector)

- 6 Reattach the sensor line and fluidics lines.



To ensure that the appropriate solutions are dispensed, make sure the label on the container matches the labeled port on the fluidics cart.

- 7 If you replaced any level sensors (other than the waste sensor), prime the affected fluidics lines.

Important: Continue with the procedure in Priming Fluidics Lines on page 71.



Replacing the Fluidics Cart Fuses

Power surges and other electrical events could cause a fuse to blow. Use the following procedure to replace the fuses.

Materials

- two replacement fuses (see Installation Kit on page 140 for ordering)
- small screwdriver

Removing Old Fuses

  To protect against shock, always turn off the cytometer and unplug the power cord before performing this procedure.

- 1 Shut down the cytometer and turn off the instrument power.
- 2 Unplug the power cord from the wall outlet and the fluidics cart.

Removing the plug allows easier access to the fuse door.

- 3 Insert a small screwdriver into the slot and gently pry the fuse door open.

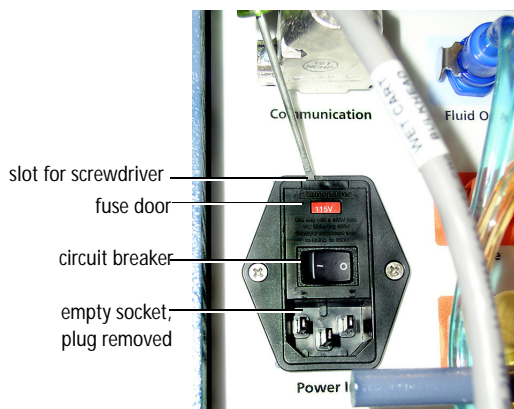

- 4 Gently pry out the fuse drawer until you can grip it.

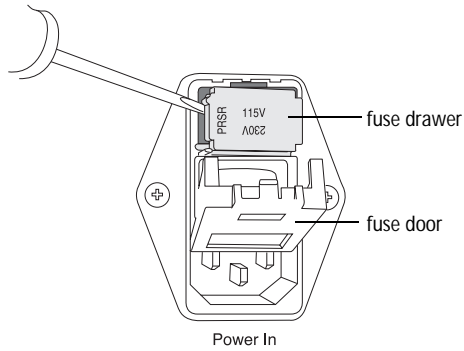

- 5 Remove the fuse drawer, and remove and dispose of the old fuses.

- Tip** Note the positions of the old fuses before you remove them. Duplicate these positions with the new fuses.

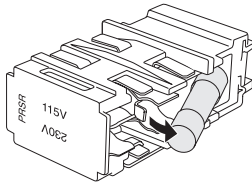

6 Replace both fuses.

Ensure that the fuses are positioned as shown.

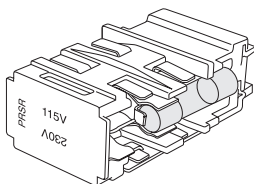

right

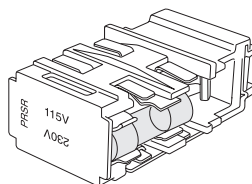

wrong

  For protection against risk of fire, replace fuses only with those provided by BD Biosciences.

7 Make sure the text for your area's voltage is right-side up.

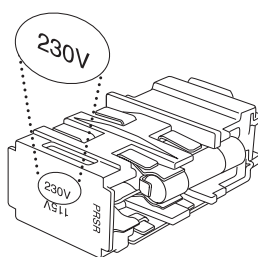
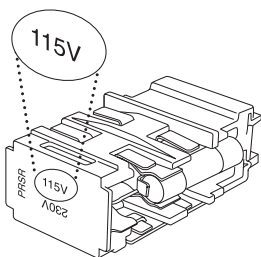

8 Slide the drawer back into the instrument until it snaps into place.

9 Close the fuse access door.

10 Reconnect the power cord to the fluidics cart.

11 Plug the cytometer power cord into the wall outlet and switch on the power.

Troubleshooting

The tips in this section can help you troubleshoot issues that might arise when using this instrument. For software troubleshooting, refer to the *BD FACSCanto Clinical Software Reference Manual*, the *BD FACSDiva Software Reference Manual*, or the *BD FACSCanto II Instructions for Use*.

If you need additional assistance, contact BD Biosciences. Refer to our website, bdbiosciences.com, for up-to-date contact information.

Troubleshooting suggestions can be found under the following topics:

- Instrument Troubleshooting on page 96
- Fluidics Cart Troubleshooting on page 101
- Loader Troubleshooting on page 102

Instrument Troubleshooting

Observation	Possible Causes	Recommended Solutions
Flow cell will not fill	Air in bubble filter	Run the Bubble Filter Purge and De-gas Flow Cell command at least once (you might need to run it several times). See Purging the Bubble Filter on page 78.
	Fluidics cart power off	Turn on the power to the fluidics cart by resetting the fluidics cart circuit breaker switch (Figure 1-9 on page 28). Always use the cytometer power button, located on the left side of the cytometer, to turn the system off and on.
	No pressure in the plenum	Check air supply components (see Figure 4-6 on page 87). <ul style="list-style-type: none"> • Check air supply connections. • Check air supply tubing for kinks.
	Sheath line disconnected	<ol style="list-style-type: none"> 1 Check cubitainer-to-fluidics cart, and fluidics cart-to-cytometer connections. See Reconnecting the Fluidics Cart Tubing on page 86. 2 Check tubing for kinks.
	BD FACSTFlow cubitainer empty	Replace the BD FACSTFlow cubitainer. See Changing a Cubitainer on page 68.
	Air in BD FACSTFlow filter (fluidics cart)	Purge air from the filter. See Purging the Fluidics Filters on page 57.
	Air lock in BD FACSTFlow filter (on fluidics cart)	See Removing an Air Lock on page 72.

Instrument Troubleshooting (continued)

Observation	Possible Causes	Recommended Solutions
Flow cell will not fill (continued)	No air pressure in cart	<ul style="list-style-type: none"> • If the cart is attached to an auxiliary air supply, switch on auxiliary air. • If the cart is not attached to an auxiliary air supply, switch off auxiliary air.
Fluidics pressure errors	Air lock in filter	Check the filter in the fluidics cart. Verify the bottom bleeder valve on the filter is fully tightened. Open the top bleeder valve. If no fluid leaks out, remove the air lock as described in Removing an Air Lock on page 72.
Fluid backfill into sample tube	Cracked tube	<ul style="list-style-type: none"> • Transfer sample to new tube. • Make sure you are using appropriate tubes. See System Requirements on page 31.
	Bal seal improperly installed or worn	Reinstall or replace the Bal seal. See Replacing the Bal Seal on page 79.
	Air lock in BD FACSDiagnose filter	See Removing an Air Lock on page 72.
	Tube partially removed from SIT after acquisition	Once you start to remove a tube from the SIT, complete the action—if you try to replace the tube after you've moved the aspirator arm, a SIT flush might occur.

Instrument Troubleshooting (continued)

Observation	Possible Causes	Recommended Solutions
Cytometer on, no response to software commands	Bad keyboard or mouse connection	Check keyboard or mouse connections to computer. Refer to the documentation that came with your workstation.
	Communication failure (Ethernet error) between computer and instrument	<ol style="list-style-type: none"> 1 Turn off the computer and the instrument. 2 Reseat the Ethernet cable, located next to the power cord on the right side of the flow cytometer. 3 Turn on the instrument, then the computer.
Software does not connect to cytometer	BD FACSDiva software running at same time as BD FACSCanto clinical software	Quit the software you are not using or put the cytometer in standby: Cytometer (Instrument) > Standby.
	Cytometer power is off	Turn power on.
	Internal firmware error	Cycle power on cytometer.
Cytometer and fluidics cart will not turn on	Power cord disconnected from wall socket or cytometer	Reconnect the power cord to the wall socket or the cytometer.
	Instrument circuit breaker tripped	Switch on the cytometer circuit breaker, followed by the instrument power (if off).
	Blown fuse in cytometer controller	Turn off the instrument main power and call BD Biosciences.

Instrument Troubleshooting (continued)

Observation	Possible Causes	Recommended Solutions
Tube does not load, or sample tube does not fit snugly on SIT	Improper tubes used	Use only uncapped 12 x 75-mm BD Falcon polystyrene test tubes, BD Trucount tubes, and BD FACS 7-color setup beads tubes. See System Requirements on page 31.
	Defective or cracked tube	<ul style="list-style-type: none"> • Transfer sample to new tube. • Make sure you are using appropriate tubes. See System Requirements on page 31.
	Bal seal improperly installed or worn	Reinstall or replace the Bal seal. See Replacing the Bal Seal on page 79.
Liquid leakage around cytometer base	Interior valve failure	<ol style="list-style-type: none"> 1 Turn off the cytometer power. 2 Clean up the liquid, using proper precautions. 3 Call BD Biosciences.
QC fails after Long Clean	Residual BD FACSClean solution in lines	Run Fluidics Startup to flush the system with sheath fluid. Repeat until QC passes.
Low laser power indication	Flow cell access door open	Close the door completely.
	Laser power output is below requirement	Call BD Biosciences.

Instrument Troubleshooting (continued)

Observation	Possible Causes	Recommended Solutions
Fluid leaking from SIT or aspirator arm	Interior valve failure or leak	<ol style="list-style-type: none">1 Turn off the cytometer power.2 Clean up the liquid, using proper precautions.3 Call BD Biosciences.
	Waste line to fluidics cart disconnected	<ol style="list-style-type: none">1 Turn off the cytometer power.2 Clean up the liquid, using proper precautions.3 Check that waste lines are securely plugged in.4 Turn on the cytometer power.

Fluidics Cart Troubleshooting

Observation	Possible Causes	Recommended Solutions
Water leakage around fluidics cart base	<ul style="list-style-type: none"> • Normal condensation overflow from pressure relief valve • Extremely humid climate 	<ol style="list-style-type: none"> 1 Turn off the cytometer power. 2 Clean up the water. 3 Empty the condensation trap in the fluidics cart daily. See Figure 1-7 on page 26.
	Bleeder valve on fluidics cart filter open	<ol style="list-style-type: none"> 1 Turn off the cytometer power. 2 Clean up the liquid. 3 Check and close all bleeder valves. See Purging the Fluidics Filters on page 57.
	Broken fluid line	Contact BD Biosciences.
Fluidics cart will not power on, cytometer on	Cart circuit breaker off	Switch on the cart circuit breaker.
	Auxiliary air supply on, cart not normally connected to auxiliary air	Toggle the auxiliary air supply off. When auxiliary air is on, the cart's own air pumps turn off.
	Power cord from fluidics cart to cytometer disconnected	Connect both ends of the cord.
	Fuse blown	Replace the fluidics cart fuses. See Replacing the Fluidics Cart Fuses on page 92.

Loader Troubleshooting

Observation	Possible Causes	Recommended Solutions
Tube does not load	Tube not completely raised	Ensure the Loader drawer is completely shut. Ensure the tube is free of bulky labels or tape.
	Tube lifter hitting carousel during ascent	Ensure the carousel is properly engaged with the alignment guide pin. If the problem persists, contact BD Biosciences for assistance.
	Tube lifter failure	Contact BD Biosciences.
Tube missed, or missing tube messages in software	Salt crystal buildup on optical sensors	Clean the tube optical sensor (outer sensor), as described in <i>Cleaning External Surfaces</i> on page 43.
	Condensation on tube	Wipe tube.
	Tube label reflection	Turn tube.
Tube runs dry, Loader not advancing to next sample	Dilute sample or rare events	Set a stopping time in BD FACSDiva software. See <i>BD FACSCanto II Instructions for Use</i> .
	Bubble in flow cell diverts stream	Degas flow cell. See <i>Removing Bubbles from the Flow Cell</i> on page 76.
	Communication error	1 Restart the system. 2 Perform fluidics startup. See <i>BD FACSCanto II Instructions for Use</i> .

Loader Troubleshooting (continued)

Observation	Possible Causes	Recommended Solutions
Tube stuck on SIT, software not responding	<ul style="list-style-type: none"> • Tube eject failure • Software problem 	<p>Manually remove the tube from the SIT.</p> <ol style="list-style-type: none"> 1 Hold the tube and move the aspirator arm aside. 2 Gently pull the tube off the SIT and replace in carousel. 3 Release the aspirator arm. 4 Restart the worklist run.
Carousel not rotating correctly	Carousel not engaged with alignment pin on drawer	Rotate the carousel on the spindle until the alignment guide pin engages with the alignment hole, and press down. See step 4 on page 39. If the problem persists, contact BD Biosciences for assistance.
	Aspirator arm bar vertical	Rotate the bar horizontally. See Changing to Automatic Loading on page 41.
Tube not detected	Tube not seated on Bal seal properly	<ul style="list-style-type: none"> • Ensure that the tube is all the way up onto the Bal seal. • Ensure you are using appropriate tubes. See System Requirements on page 31. • Replace or Reinstall Bal seal
	Optical sensor is wet	<ul style="list-style-type: none"> • Allow time for sensor to dry • Reduce solution volumes to ≤ 3 mL

Appendix A

Technical Overview

This appendix provides more information about these topics.

- Flow Cytometry on page 106
- Fluidics System on page 106
- Optics System on page 109
- Electronics System on page 119

Flow Cytometry

Flow cytometry measures certain properties of particles, such as size and internal complexity, using light. To do this, a flow cytometer needs a method to move the particles past a light source. It also needs a way to collect and convert the light scattered or emitted by the particles into electrical signals. Most modern cytometers use lasers as the light source and transport the particles under investigation past the lasers using fluid or air.

The major systems in a cytometer that moves particles by fluid transport include

- a fluidics system
- an optical system
- an electronics system

Fluidics System

A fluidics system in a flow cytometer moves particles in fluid through a flow cell, past a laser beam, and then into a waste tank.

Sheath Cubitainer to Flow Cell

On the BD FACSCanto II flow cytometer, a separate fluidics cart houses the sheath cubitainer, cleaning fluid cubitainers, and the waste tank. Positive-pressure pumps in the cart send sheath fluid past a 0.22- μm filter to a pressurized interior reservoir within the cytometer, called the plenum. The plenum maintains a nearly constant fluid level and dampens pump pulsation. As a result, sheath pressure does not vary with the level of fluid in the sheath cubitainer. The plenum delivers sheath fluid that has been filtered for air via a bubble filter to the flow cell with minimal flow rate variations. Figure A-1 on page 107 shows the fluidics pathway for the BD FACSCanto II system.

Figure A-1 Sheath and sample flow pathways for the BD FACSCanto II cytometer

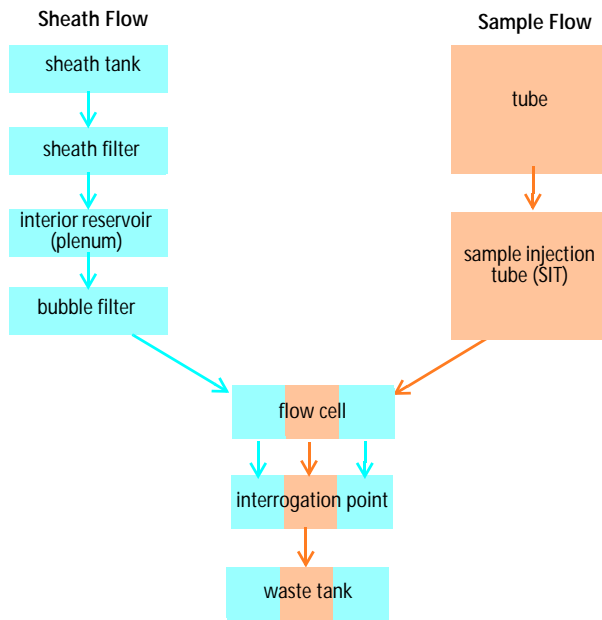

You can view the current sheath fluid pressure in BD FACSCanto clinical software by displaying the Status window. In BD FACSDiva software select Instrument > Instrument Status Report.

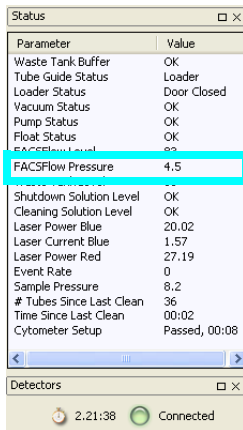

BD FACSCanto clinical software

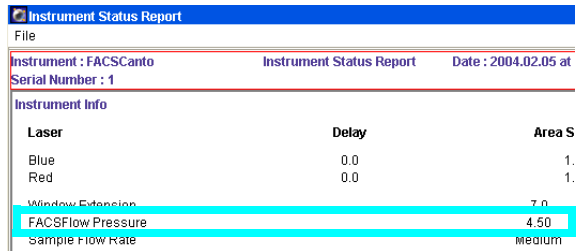

BD FACSDiva software

Tube to Flow Cell

When you place a tube on the cytometer, sample travels up the sample injection tube (SIT) in a separate, pressurized stream. It arrives in the lower chamber of the flow cell at a slightly higher pressure relative to the sheath fluid. The conical shape of the lower chamber creates a hydrodynamic focusing that carries the sample particles in a stable stream upward through the center of the flow cell. In the flow cell, laser beams interrogate the sample, one particle at a time. (Figure A-2).

The difference in pressure between the sample stream and sheath fluid stream can be used to vary the diameter of the sample stream, also known as the sample core. Increasing the sample pressure increases the core diameter and therefore the flow rate (Figure A-2).

- A higher flow rate is generally used for measurements such as immunophenotyping. The data is less resolved but is acquired more quickly.
- A lower flow rate is generally used in applications where greater resolution is critical.

Figure A-2 Hydrodynamic focusing of the sample core through the flow cell

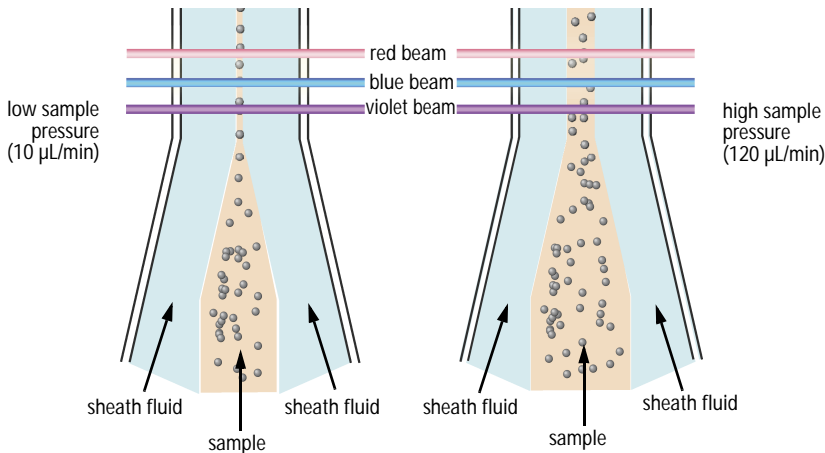

When using BD FACSCanto clinical software, the cytometer automatically regulates the sample pressure according to the currently selected panel.

Optics System

As stained cells or other particles pass through the focused laser beam, they scatter the laser light and fluoresce. Because the laser beam is focused and particles move rapidly through the flow cell, the scatter or fluorescence emission has a very brief duration—only a few microseconds. This brief flash of light is collected, filtered, and then converted into an electrical signal by the detectors.

Figure A-3 Light pathway through the BD FACSCanto II flow cytometer

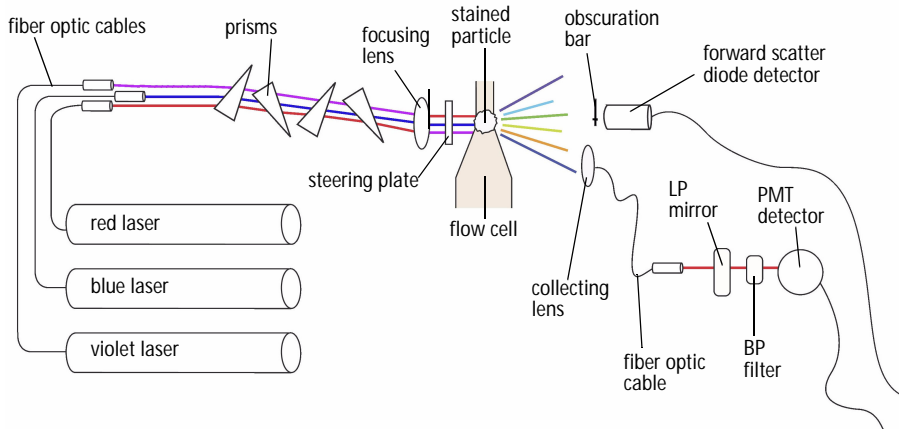

Light Scatter

When a cell or particle passes through a focused laser beam, laser light is scattered in all directions (Figure A-4). Light that scatters roughly in the same direction as the laser beam is called forward scatter (FSC); light that scatters roughly perpendicular to the laser beam is called side scatter (SSC). FSC and SSC intensities indicate physical properties of cells:

- FSC—indicates relative differences in the size of the cells or particles
- SSC—indicates relative differences in the internal complexity or granularity of the cells or particles

Figure A-4 Forward scatter (FSC) and side scatter (SSC)

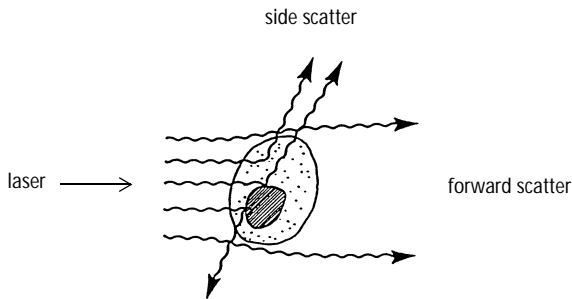

Fluorescence

When cells or particles stained with fluorochrome-conjugated antibodies or other dyes pass through a laser beam, the dyes can absorb photons (energy) and be promoted to an excited electronic state. In returning to their ground state, the dyes release energy, most of which is emitted as light. This light emission is known as fluorescence.

Fluorescence is always a longer wavelength (lower-energy photon) than the excitation wavelength. Some fluorescent compounds emit at a much longer wavelength than their excitation wavelength. PerCP absorbs blue light (488 nm) and emits red light (675 nm); other fluorochromes, such as FITC, absorb blue light (488 nm) and emit green light (530 nm). These differences between excitation and emission allow one laser to excite many fluorochromes.

The emission spectra for some commonly used fluorochromes are shown in Figure A-5.

Figure A-5 Emission spectra of commonly used fluorochromes

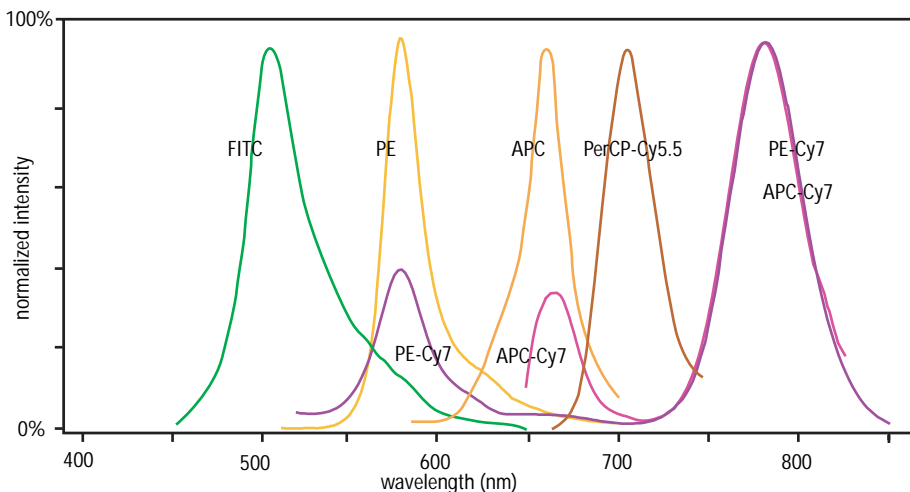

Optical Filters

Optical filters modify the spectral distribution of light scatter and fluorescence directed to the detectors. When photons encounter an optical filter, they are either transmitted, absorbed, or reflected.

Figure A-6 Effect of an optical filter on incident photons

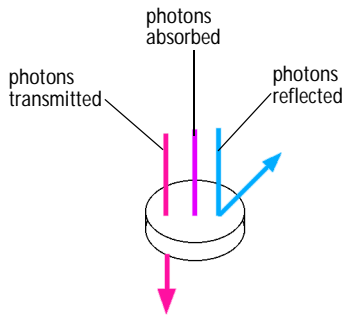

Two kinds of filters are used on the BD FACSCanto II flow cytometer (default configuration):

- longpass (LP)
- bandpass (BP)

Longpass Filter

In general, LP filters (mirrors) pass wavelengths longer than the filter rating. For example, a 500 LP filter permits wavelengths longer than 500 nm to pass through it and either absorbs or reflects wavelengths shorter than 500 nm (Figure A-7 on page 113).

Figure A-7 Longpass filter

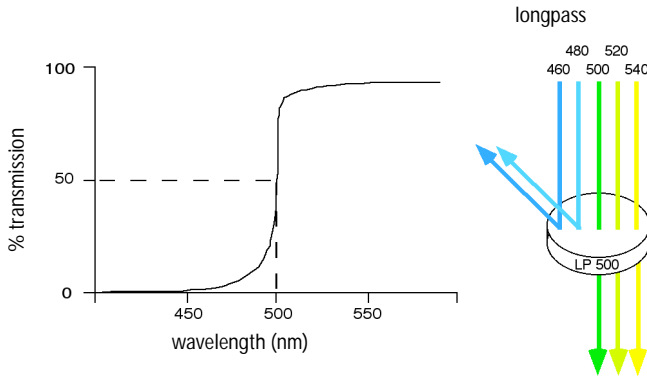

Not all light with shorter wavelengths is absorbed or reflected. Some will still pass through.

Bandpass Filter

A BP filter transmits a relatively narrow range or band of light. Bandpass filters are typically designated by two numbers. The first number indicates the center wavelength and the second refers to the width of the band of light that is passed. For example, a 500/50 BP filter transmits light that is centered at 500 nm and has a total bandwidth of 50 nm. Therefore, this filter transmits light efficiently between 475 and 525 nm.

Figure A-8 Bandpass filter

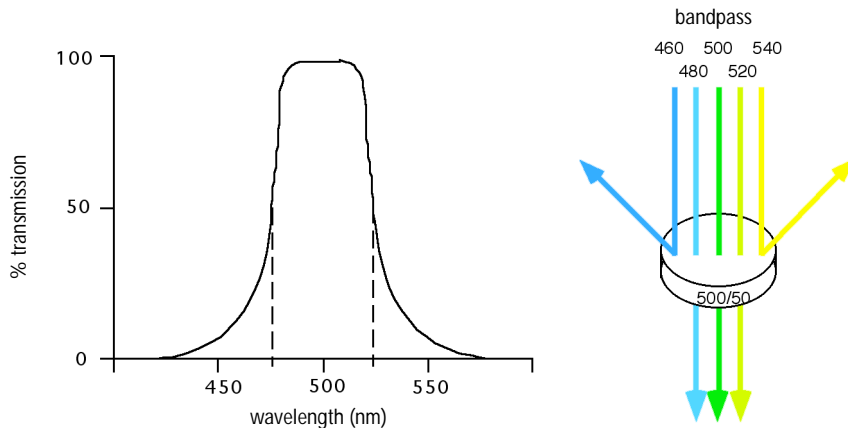

Detectors

Detectors convert light signals into electrical signals that can be processed by the electronics system and a computer and then displayed on a plot.

There are two types of signal detectors in the BD FACSCanto II flow cytometer: the photodiode and the photomultiplier tube (PMT). The photodiode is used to detect the stronger FSC signal (generated by light from the blue laser). The more sensitive PMTs are used to detect the weaker signals generated by SSC and all fluorescence channels.

In BD FACSCanto clinical software, the fluorochrome (or cell parameter) to be measured at each PMT is preset.

In BD FACSDiva software, you can use the Instrument Configuration dialog to specify the fluorochrome that will be measured at each PMT detector. You can also add additional parameters to your configuration and choose the appropriate fluorochrome within your software experiment.

Detector Arrays

On BD FACSCanto II flow cytometers, PMTs are organized onto an octagon and one or two trigons. The octagon has five or six PMTs. The trigons have two or three PMTs. These arrays efficiently direct the emitted light from each fluorochrome to a specific PMT, through placement of LP mirrors and BP filters.

When the collected light leaves the fiber optic cable at the octagon, it first meets a 735 LP dichroic mirror (Figure A-9 on page 115). The mirror allows light with wavelengths greater than 735 nm to pass and reflects light with lower wavelengths to the next PMT.

Figure A-9 Light pathway around an octagon (4-2 configuration)

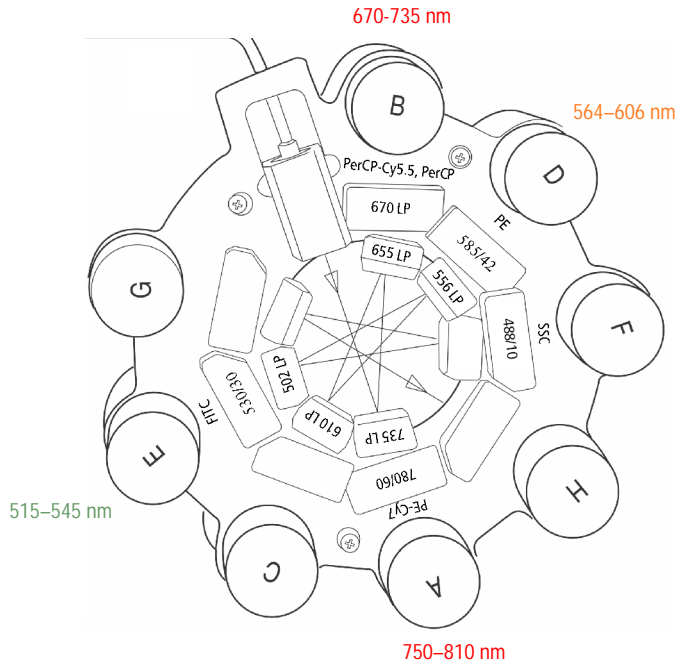

Behind the LP mirror, a 780/60 BP filter admits light from 750 to 810 nm and substantially blocks other wavelengths. The light that finally reaches PMT A will be from dyes such as PE-Cy7 that emit in this range.

Figure A-10 Excitation and emission spectra of PE-Cy7

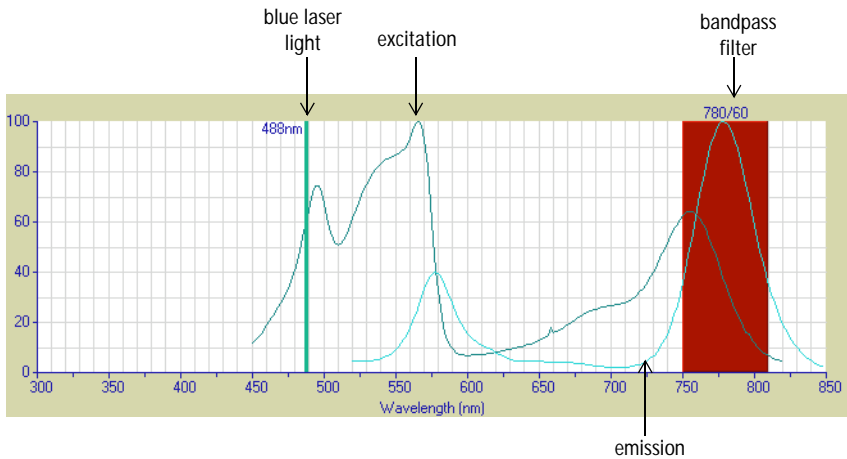

Similarly, the 655 LP mirror for PMT B will reflect light with a wavelength of less than 655 nm to the next PMT. Light with a longer wavelength will pass through to another LP filter (670 nm) that further blocks shorter wavelength light. Light from dyes such as PerCP-Cy5.5 pass through this filter.

The beam continues around the array, with different light spectrum ranges collected at successive PMTs. Side scatter signals (blue laser light that was deflected by the internal irregularities of a particle) are collected at PMT F.

Spillover

The arrangement of filters and mirrors in the BD FACSCanto II enables each PMT to receive signals predominantly from a specific fluorochrome.

However, fluorochromes emit light over a range of wavelengths. As a result, a signal from one fluorochrome can appear in a detector used for another fluorochrome.

Figure A-11 Spillover of FITC into PE detector

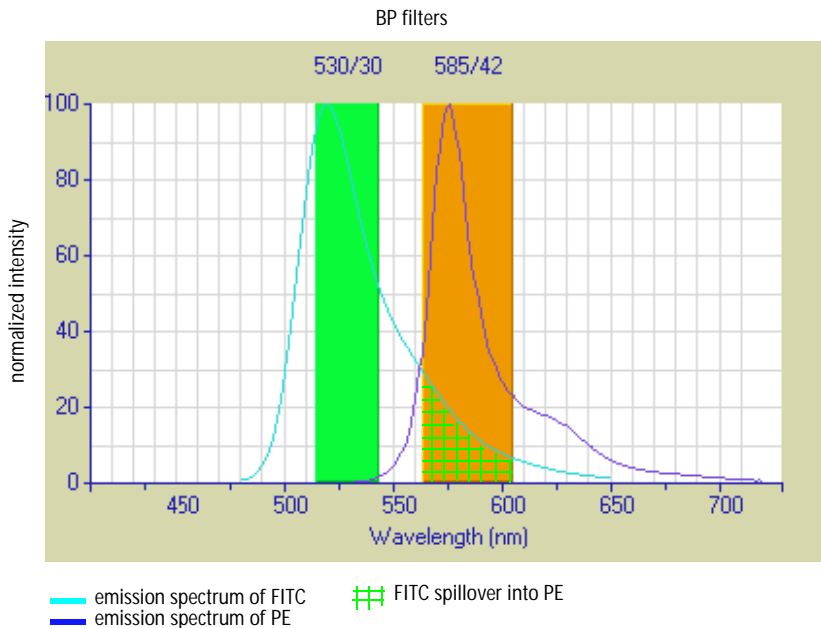

For example, FITC appears primarily in the FITC detector, but some of its fluorescence spills over into the PE detector. PE appears primarily in the PE detector, but some of its fluorescence spills over into the FITC detector. This spillover must be corrected (or compensated for).

Figure A-11 shows that a portion of the FITC emission will be detected by both the FITC and PE channels. This can be seen in an x, y plot of FITC vs PE (Figure A-12 on page 118).

The green circle represents a population stained with FITC. The gray circle represents a population negative for both FITC and PE.

Figure A-12 Theoretical display of FITC vs PE before compensation

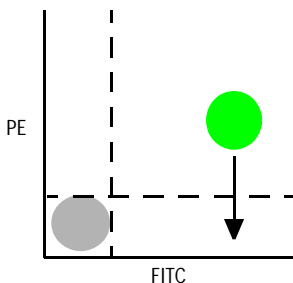

If the fluorescence is to be assigned to PE, the FITC signal must be removed from the PE channel, as indicated by the arrow. Both PE and FITC fluoresce in the yellow (575 nm) range, so there is no way to isolate the emission from each fluorochrome optically. Instead, fluorescence compensation moves the FITC population out of the PE positive area (Figure A-13).

Figure A-13 FITC signal properly compensated out of the PE channel

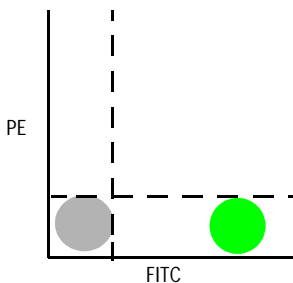

The software automatically determines these compensations during setup, which you can also manually adjust:

- In BD FACSCanto clinical software, adjust spectral overlap on the Spectral Overlap tab.
- In BD FACSDiva software, adjust spectral overlap in the Compensation tab in the Instrument frame.

Once compensation has been set for one sample, the spectral overlap setting (compensation value) remains valid whether a dim or bright sample is run. Figure A-14 illustrates this principle. Although the signals differ in intensity, the percentage of signal detected in the FITC and PE channels remains constant.

Figure A-14 Two FITC signals of different intensity

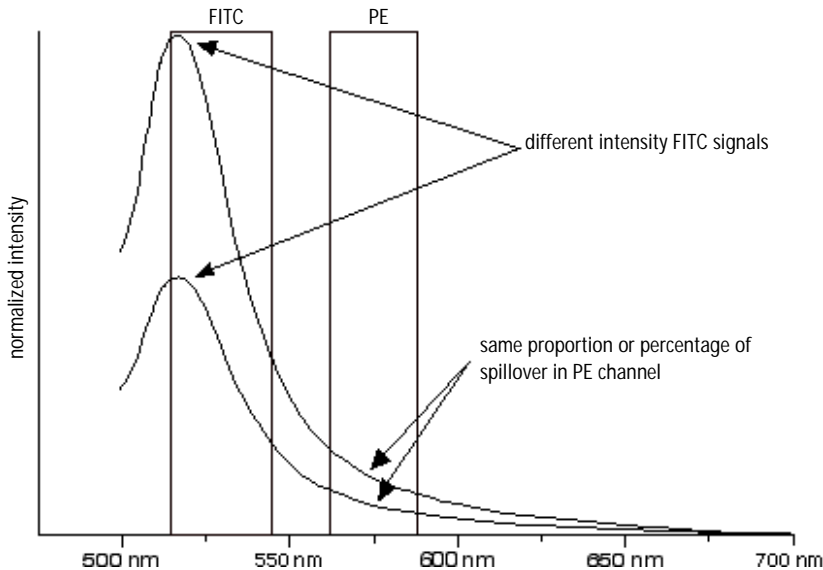

Electronics System

Any discussion of digital electronics requires a basic understanding of the *bit*.

Computers and digital circuits use bits (binary numbers consisting of ones and zeros) to pass information. A 4-bit number has 4 binary digits that are either 1 or 0. A 10-bit number has 10 binary digits that are either 1 or 0. An 18-bit number has 18 binary digits that are either 1 or 0.

100100101011101010 is an example of an 18-bit number. Converted into base 10, the scale we normally use, this number is *150,250*. There are *262,144* 18-bit values.

Pulses

Inside the PMTs, the laser light is converted into an electrical signal. This electrical signal is called a pulse.

Figure A-15 Anatomy of a pulse

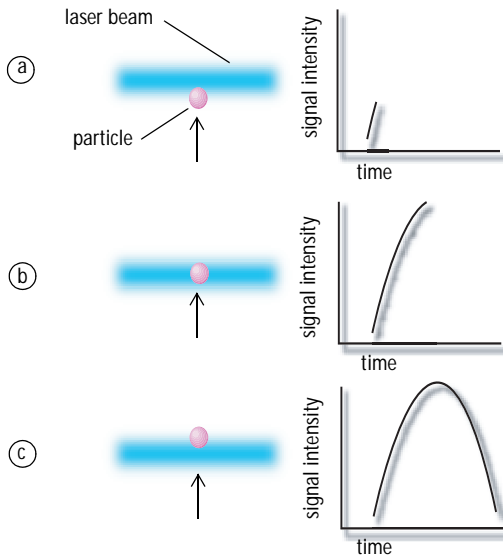

- (a) A pulse begins when a particle enters the laser beam. At this point, both the beam intensity and signal intensity are low.
- (b) The pulse reaches a maximum intensity or height when the particle reaches the middle of the beam, where the beam and signal intensity are the brightest. The peak intensity, or height of the pulse, is measured at this point.
- (c) As the particle leaves the beam, the pulse trails off.

Pulse Measurements

The pulse travels from the PMTs to the electronics board within the cytometer.

Figure A-16 Electronics board

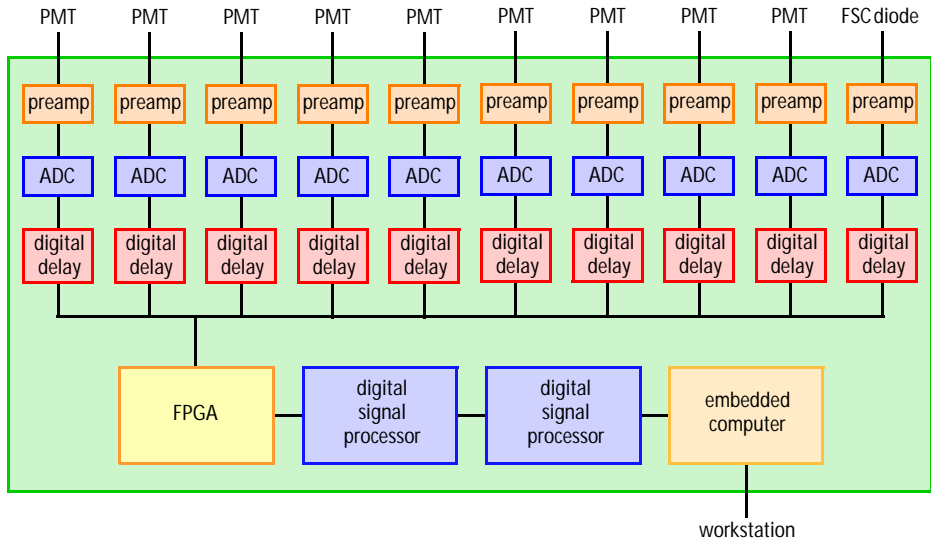

The pulse is amplified and then sent to a 14-bit analog-to-digital converter (ADC) that changes the analog (continuous) pulse into digital (discrete) data. The ADC does this by sampling the pulse up to 10 million times per second, slicing it into 16,384 levels, and assigning a measurement to each time sample.

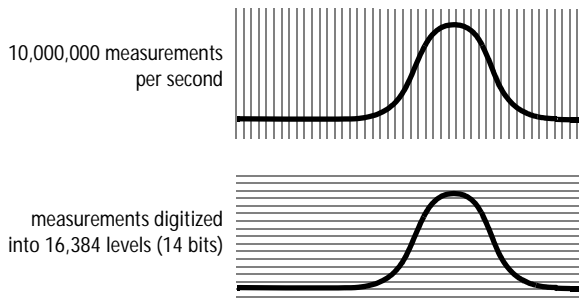

The ADC sends these pulse measurements to a programmable digital delay, so that the numbers can be adjusted in time to account for the spatial displacement of the two excitation laser beams (blue and red). After the numbers pass through the digital delay and are aligned, the numbers are then sent to a field programmable gate array (FPGA) for further processing.

During this process, when a pulse exceeds the user-assigned threshold, its height and area are simultaneously calculated by the FPGA.

Figure A-17 Pulse measurements

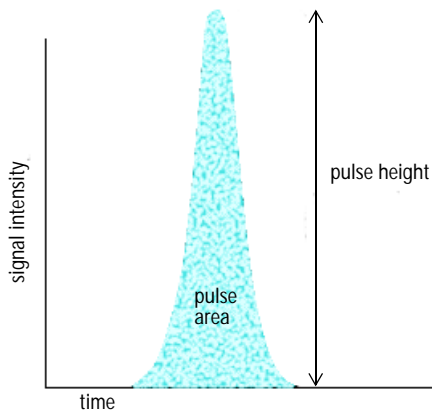

An FPGA calculates pulse height and area in the following manner:

- The maximum digitized value of all signal intensity measurements for the pulse becomes the pulse height.
- The sum of all signal intensity measurements that occur within a discrete time period becomes the pulse area.

After height and area calculations occur, they are sent to the signal processors.

Compensation, Gating, and Scaling

The digital signal processors (DSPs), located on the acquisition boards and on the master board, perform several important functions including:

- correcting for spillover between fluorochromes through a series of mathematical calculations (referred to as *compensation*)
- window gating
- scaling and clipping

Scaling

The DSPs take the values determined by the FPGAs and convert them from integer numbers to IEEE-754, 32-bit floating-point numbers. When calculating area, the electronics add all data points under the pulse, in effect increasing the resolution from 16,384 maximum levels of measurement (14 bits) to close to 16,000,000. For a typical pulse of 2-3 microseconds in width, this is equivalent to approximately 18 bits (262,144 levels). In order to normalize the height to the area measurement, the electronics multiplies the height by 16 ($16,384 \times 16 = 262,144$). To more finely adjust the area to match the height scale, the DSP applies a floating point scale factor to the area measurement. After the scale factor is applied, the DSP checks the number and limits it (clips) to 262,143.

Because data has been converted into 18-bits, an 18-bit display is used to keep all data on scale. That means a pulse (an event), will fall into one of 262,144 digital bins, or channels, when it is eventually assigned to a dot plot or histogram.

Embedded Computer

The electronics board includes an embedded computer that sends pulse measurements and other data from the cytometer to your workstation.

For more about digital theory, refer to Appendix B in the *BD FACSDiva Software Reference Manual*. For an in-depth discussion, visit our website at bdbiosciences.com/immunocytometry_systems/ and download the *BD FACSDiva Option White Paper*.

Appendix B

Optics Configurations

This appendix describes the components for each of the BD FACSCanto II optics configurations.

- 4-2 Optics Configuration on page 126
- 4-2-2 Optics Configuration on page 130
- 5-3 Optics Configuration on page 134

4-2 Optics Configuration

The 4-2 configuration can collect four fluorescence signals from a blue laser source and two fluorescence signals from a red laser source.

Excitation Optics

The BD FACSCanto II instrument excitation optics consist of lasers, fiber optic cables, beam-shaping prisms, and an achromatic focusing lens, as shown in Figure 1-3 on page 20. The 4-2 configuration uses low-powered air-cooled and solid state lasers that do not have special power and cooling requirements.

Laser	Wavelength (nm)	Commonly Used Fluorochromes
Coherent Sapphire Solid State	488 (blue)	FITC, PE, PE-Cy7, PerCP, PerCP-Cy5.5
JDS Uniphase HeNe Air Cooled	633 (red)	APC, APC-Cy7

Collection Optics

The BD FACSCanto II 4-2 configuration collection optics include one octagon and one trigon detector array.

The octagon contains five PMTs and detects light from the 488-nm (blue) laser. One PMT in the octagon collects side scatter (SSC) signals.

The trigon contains two PMTs and detects light from the 633-nm (red) laser.

The 4-2 configuration octagon and trigon arrays have filter and mirror combinations as shown in Table B-1 on page 127, Figure B-1 on page 128, and Figure B-2 on page 129.

Table B-1 4-2 configuration optical filters

Detector Array (Laser)	PMT Position	LP Mirror	BP Filter or LP Mirror	Intended Dye
Octagon (488-nm blue laser)	A	735	780/60	PE-Cy7
	B	655	670	PerCP-Cy5.5 or PerCP
	C	610	blank optical holder	—
	D	556	585/42	PE
	E	502	530/30	FITC
	F	blank optical holder	488/10 and pinhole	SSC
	G	blank optical holder	blank optical holder	—
	H	—	blank optical holder	—
Trigon (633-nm red laser)	A	735	780/60	APC-Cy7
	B	685	blank optical holder	—
	C	—	660/20	APC

Figure B-1 4-2 configuration octagon detector array

488 nm blue laser

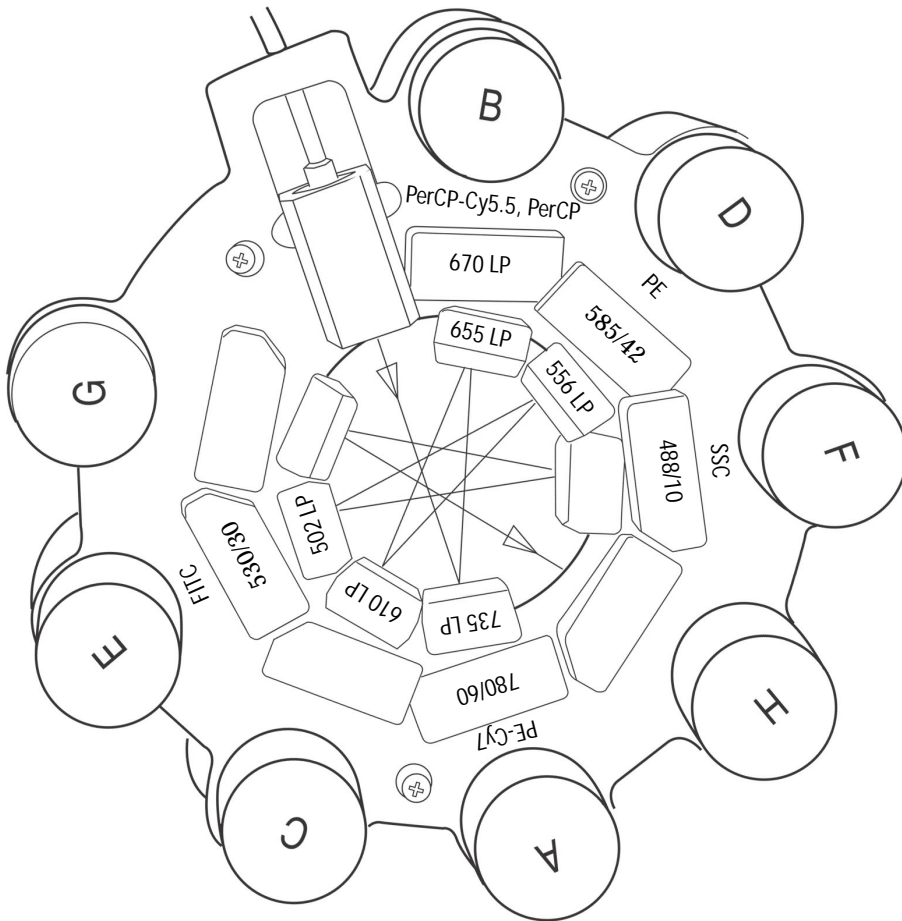
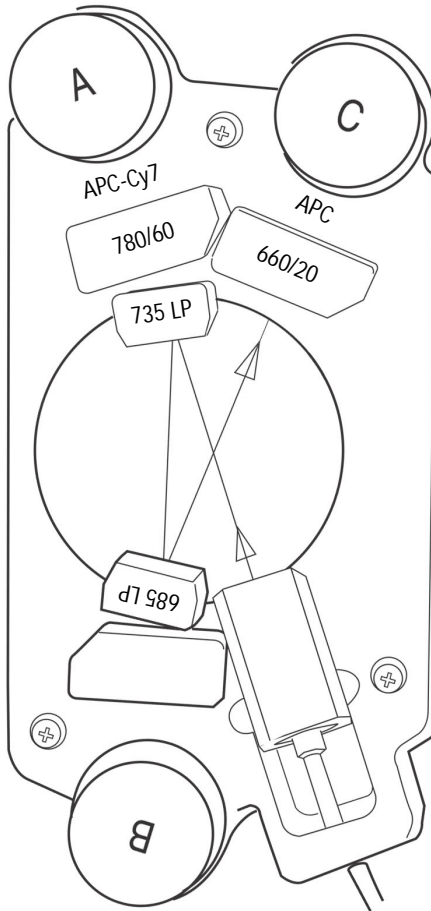

Figure B-2 4-2 configuration trigon detector array
633 nm red laser



4-2-2 Optics Configuration

The 4-2-2 configuration can collect four fluorescence signals from a blue laser source, two fluorescence signals from a red laser source, and two fluorescence signals from a violet laser source.

NOTICE The BD FACSCanto II system is cleared for use with six-color assays. The development of seven- and eight-color assays on this device will require validation prior to use as a diagnostic procedure.

Excitation Optics

The BD FACSCanto II instrument excitation optics consist of lasers, fiber optic cables, beam-shaping prisms, and an achromatic focusing lens, as shown in Figure 1-3 on page 20. The 4-2-2 configuration uses low-powered air-cooled and solid state lasers that do not have special power and cooling requirements.

Laser	Wavelength (nm)	Commonly Used Fluorochromes
Coherent Sapphire solid state	488 (blue)	FITC, PE, PE-Cy7, PerCP, PerCP-Cy5.5
JDS Uniphase HeNe air cooled	633 (red)	APC, APC-Cy7
Point Source™ iFLEX™2000-P-1-405-0.65-30-NP	405 (violet)	Pacific Blue™, AmCyan

Collection Optics

The BD FACSCanto II 4-2-2 configuration collection optics include one octagon and two trigon detector arrays.

The octagon contains five PMTs and detects light from the 488-nm (blue) laser. One PMT in the octagon collects side scatter (SSC) signals.

Both trigons contain two PMTs. One detects light from the 633-nm (red) laser. The other detects light from the 633-nm (violet) laser.

The 4-2 configuration octagon and trigon arrays have the filter and mirror combinations as shown in Table B-2, Figure B-3 on page 132, and Figure B-4 on page 133.

Table B-2 4-2 configuration optical filters

Detector Array (Laser)	PMT Position	LP Mirror	BP Filter or LP Mirror	Intended Dye
Octagon (488-nm blue laser)	A	735	780/60	PE-Cy7
	B	655	670	PerCP-Cy5.5 or PerCP
	C	610	blank optical holder	—
	D	556	585/42	PE
	E	502	530/30	FITC
	F	blank optical holder	488/10 and pinhole	SSC
	G	blank optical holder	blank optical holder	—
	H	—	blank optical holder	—
Trigon (633-nm red laser)	A	735	780/60	APC-Cy7
	B	685	blank optical holder	—
	C	—	660/20	APC
Trigon (405-nm violet laser)	A	502	510/50	AmCyan
	B	blank optical holder	450/50	Pacific Blue™
	C	—	blank optical holder	—

Figure B-3 4-2-2 configuration octagon detector array

488 nm blue laser

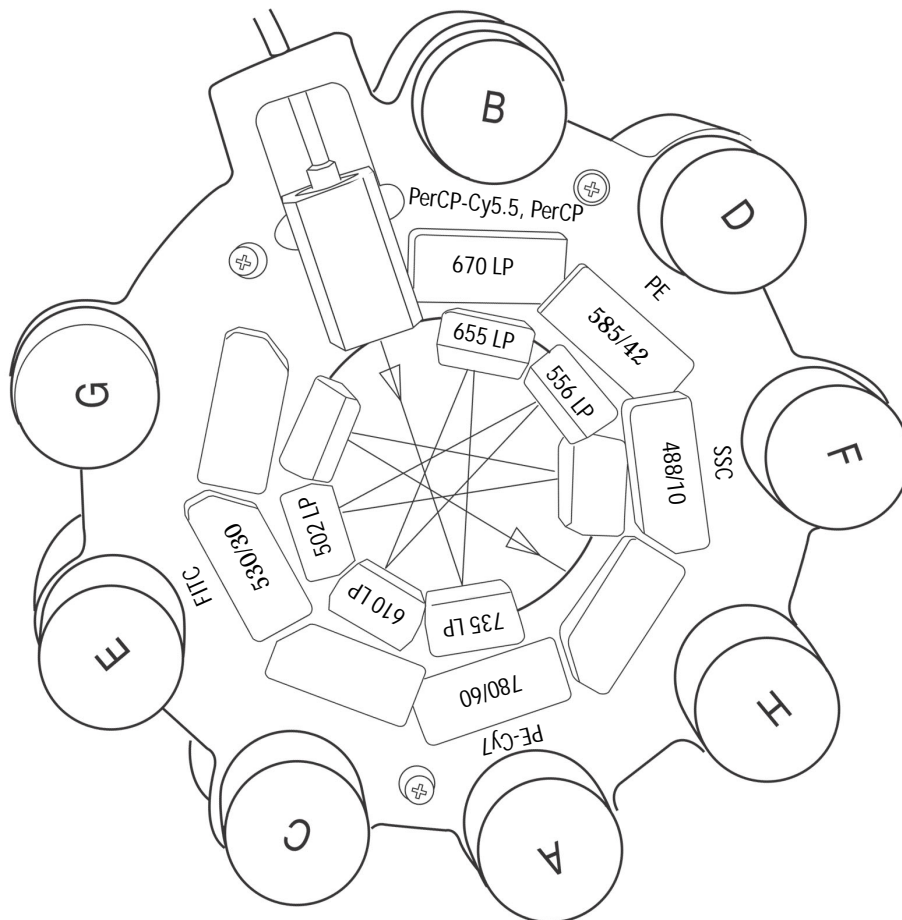
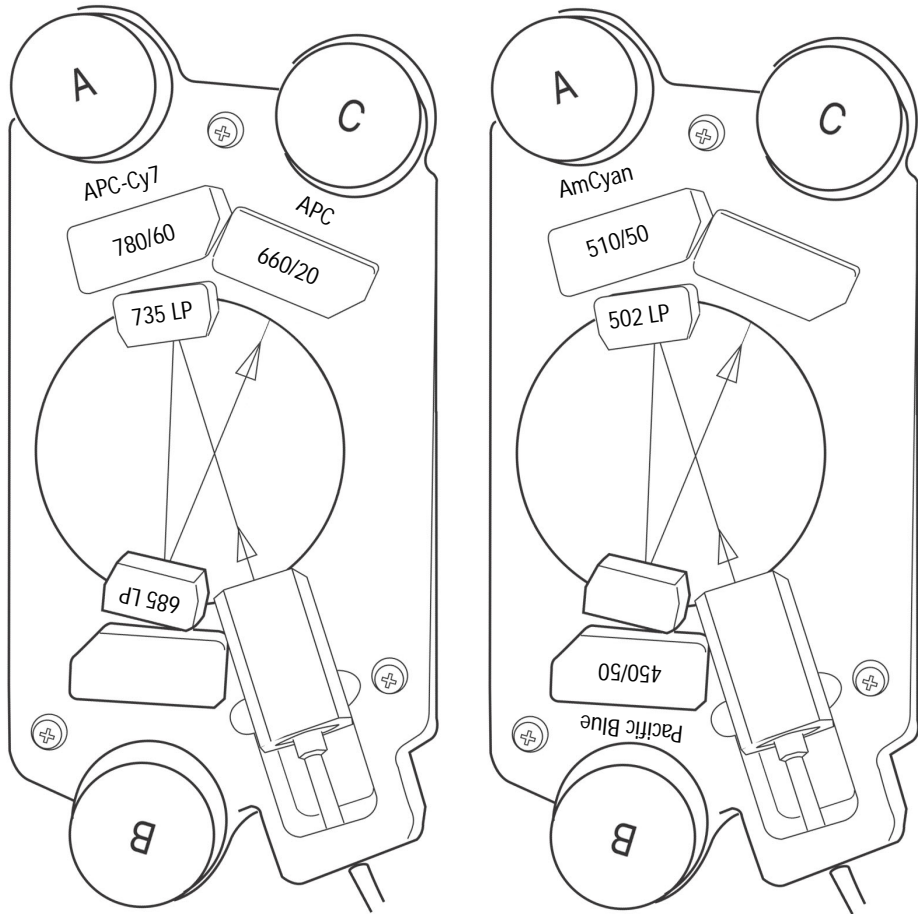

Figure B-4 4-2-2 configuration trigon detector arrays

633 nm red laser

405 nm violet laser



5-3 Optics Configuration

The 5-3 configuration can collect five fluorescence signals from a blue laser source and three fluorescence signals from a red laser source.

NOTICE The BD FACSCanto II system is cleared for use with six-color assays. The development of seven- and eight-color assays on this device will require validation prior to use as a diagnostic procedure.

Excitation Optics

The BD FACSCanto II instrument excitation optics consist of lasers, fiber optic cables, beam-shaping prisms, and an achromatic focusing lens, as shown in Figure 1-3 on page 20. The 5-3 configuration uses low-powered air-cooled and solid state lasers that do not have special power and cooling requirements.

Lasers	Wavelength (nm)	Commonly Used Fluorochromes
Coherent Sapphire Solid State	488 (blue)	FITC, PE, PE-Texas Red®, PerCP, PerCP-Cy5.5, PE-Cy7
JDS Uniphase HeNe Air Cooled	633 (red)	APC, APC-Cy7, Alexa Fluor® 700

Collection Optics

The BD FACSCanto II 5-3 configuration collection optics include one octagon and one trigon detector array.

The octagon contains six PMTs and detects light from the 488-nm (blue) laser. One PMT in the octagon collects side scatter (SSC) signals.

The trigon contains three PMTs and detects light from the 633-nm (red) laser.

The 5-3 configuration octagon and trigon arrays have the filter and mirror combinations as shown in Table B-3 on page 135, Figure B-5 on page 136, and Figure B-6 on page 137.

Table B-3 5-3 configuration optical filters

Detector Array (Laser)	PMT Position	LP Mirror	BP Filter or LP Mirror	Intended Dye
Octagon (488-nm blue laser)	A	735	780/60	PE-Cy7
	B	655	670	PerCP-Cy5.5 or PerCP
	C	610	616/23	PE-Texas Red®
	D	556	585/42	PE
	E	502	530/30	FITC
	F	blank optical holder	488/10 and pinhole	SSC
	G	blank optical holder	blank optical holder	—
	H	—	blank optical holder	—
Trigon (633-nm red laser)	A	735	780/60	APC-Cy7
	B	685	712/21	Alexa Fluor® 700
	C	—	660/20	APC

Figure B-5 5-3 configuration octagon detector array

488 nm blue laser

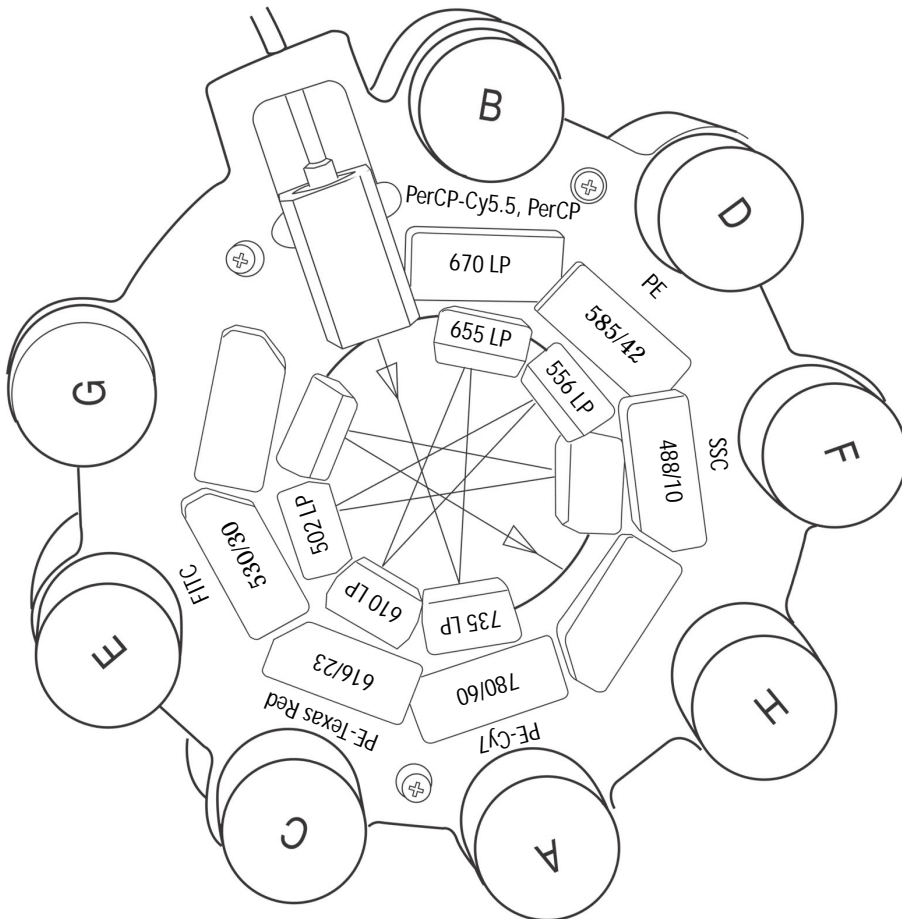
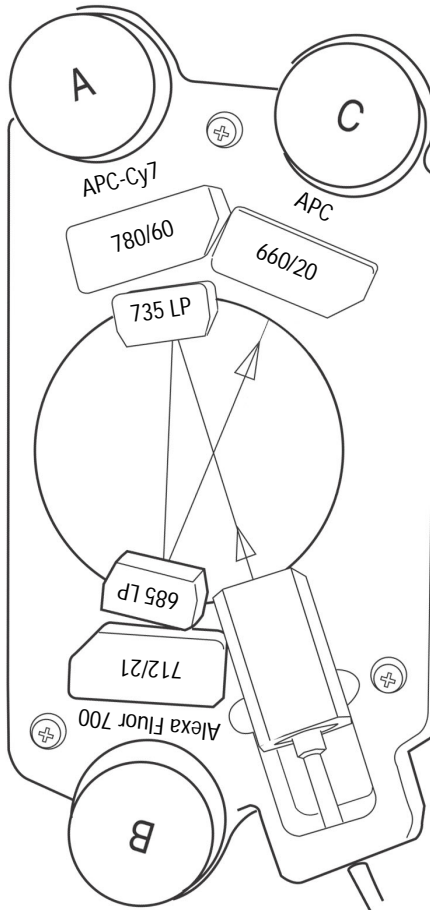

Figure B-6 5-3 configuration trigon detector array
633 nm red laser



Appendix C

Supplies and Replacement Parts

To order supplies and options, contact your local BD Biosciences representative.

For updated information and part numbers, refer to our website, bdbiosciences.com.

- Instrument Supplies on page 140
- Consumables on page 142

Instrument Supplies

Installation Kit

The instrument ships with an installation kit including the following items, many of which are used during installation. Use these part numbers to order replacements.

Item	Part No.
Fluid filter	331394
1/4-in. elbow couplings	333072
6-ft cordset for US power (15A, 5-15P/320-C13)	337219
2.5-m cordset for Australian power (10A C13)	335696
2.5-m cordset for European power (10A C13)	335697
2.5-m cordset for UK power (10A C13 R/A)	335698
Filter bypass assembly	33576007
Bal seal for SIT	343509
Bal seal removal tool	331430
12 x 75-mm tubes	343675
10-L waste tank	340261
Vented cap for waste tank	338922
Waste cap baffle	338505
Fluidics cart fuses: 2.5-A 250V Slo-blo Type T	343565
Loader front door assembly (Loader option only)	34401007
Loader side door assembly (Loader option only)	34349207

Other Replacement Parts

Item	Part No.
Sheath sensor probe (2-level)	338979
Waste sensor probe (2-level)	338978
Auxiliary sensor probe (1-level)	343835
Air filter (side door)	336303
Bal seal retainer	640116
Carousel kit, carousels 1–4	332727
Carousel kit, carousels 5–8	332728
Carousel kit, carousels 9–12	332729
Carousel kit, carousels 13–16	332730

Bar Code Reader Parts

Item	Part No.
2D bar code reader	344025
Stand (bar code reader)	344026

Consumables

Instrument Setup

Particle	Supplier	Catalog No.
BD FACS 7-color setup beads	BD Biosciences (877) 232-8995	335775

Reagents

Reagent	Supplier	Catalog No.
BD FACSThrow sheath fluid	BD Biosciences (877) 232-8995	340398 (US and Latin America) 342003 (other countries)
BD FACSClean solution	BD Biosciences	340345
BD FACS shutdown solution	BD Biosciences	334224
Monoclonal antibodies	BD Biosciences	a
BD FACSThrow lysing solution ^b	BD Biosciences	349202

a. Refer to the BD Biosciences Immunocytometry Products Catalog or the BD Biosciences website (bdbiosciences.com).

b. US Patent Nos. 4,654,312; 4,902,613; 5,098,849

Labware

Item	Supplier	Catalog No.
5-mL polystyrene test tubes, 12 x 75-mm (BD Falcon tubes) <ul style="list-style-type: none">• uncapped, 125 per bag• capped, 125 per bag• capped, 25 per bag• with cell-strainer cap, 25 per bag	BD Biosciences (877) 232-8995	<ul style="list-style-type: none">• 352052• 352054• 352058• 352235

Appendix D

Technical Specifications

- Cytometer Specifications on page 146
- Fluidics Cart Specifications on page 150
- BD FACS Loader Specifications on page 151

For barcode reader specifications, refer to the information supplied by the manufacturer.

Cytometer Specifications

Dimensions	Height: 64 cm (25.2 in.) Width: 91 cm (35.7 in.) Depth: 61 cm (24 in.)
Workspace dimensions	Height (with flow cell access door open): 85 cm (33.5 in.) Unit designed to fit lab bench 55.9 cm (22 in.) depth.
Operational clearances, cytometer	Left side: 30 cm (11.8 in.) between unit and other objects or wall to permit proper air flow and access to the main power button and circuit breaker Right side: 30 cm (11.8 in.) between unit and other objects or wall to permit proper air flow Top: 22.5 cm (8.9 in.) between unit and other objects or wall to permit opening of flow cell access door
Weight	≤146 kg (320 lb)—cytometer only, excluding Loader and computer Maximum 168 kg (370 lb)—including Loader
Power requirements	100/115/230 VAC (50–60 Hz) Current: 5A at 115 VAC 2.5A at 230 VAC
Power consumption	500 W

Environment

Storage temperature	5–40°C (41–104°F)
Operating temperature	16–31°C (59–86°F)
Operating relative humidity	20–80% (noncondensing)
Noise level	≤62 dBA
Facilities	No special room requirements

Performance

Fluorescence threshold sensitivities	FITC <100 MESF PE <50 MESF
Forward and side scatter sensitivity	Platelets can be resolved from noise
Forward scatter sensitivity	1 micron
Side scatter sensitivity	0.5 micron

Optics

Laser Specifications

The following Class 3B lasers are mounted on the BD FACSCanto II instrument.

Manufacturer	Model	Wavelength (nm)	Power (mW)
Coherent	Sapphire 488-20	488	20
JDS Uniphase	1144-P	633	17
Point Source (optional)	iFLEX2000-P-1-405-0.65-30-NP	405	30

These lasers are contained within the instrument, therefore the BD FACSCanto II flow cytometer is a Class I (1) laser product.

Excitation Optics

Optical platform	Fixed optical assembly
Beam geometry (all lasers)	9 μm x 65 μm elliptical beam

Emission Optics

Collection lens	Optical gel-coupled to flow cell Numerical aperture (NA) = 1.2
Fluorescence detection	6 to 8 photomultiplier tube detectors: Wavelength ranges detected from 488-nm laser: <ul style="list-style-type: none">• 750–810 nm (PE-Cy7)• 670–735 nm (PerCP-Cy5.5)• 610–637 nm (PE-Texas Red®, optional)• 564–606 nm (PE)• 515–545 nm (FITC) Wavelength ranges detected from 633-nm laser: <ul style="list-style-type: none">• 750–810 nm (APC-Cy7)• 701–723 nm (Alexa Fluor® 700, optional)• 650–670 nm (APC) Wavelength ranges detected from 405-nm laser: <ul style="list-style-type: none">• 502–535 nm (AmCyan)• 425–475 nm (Pacific Blue™)
Forward scatter detection	Photodiode with 488/10 bandpass filter
Side scatter detection	PMT with 488/10 bandpass filter

Fluidics

General operation	Integrated fluidics cart with automated startup, shutdown, and cleaning cycles
Sheath consumption	1.1 L/hr, normal operation <1.0 mL/hr, standby
Sample flow rates	Assay dependent, controlled automatically by BD FACSCanto clinical software. Nominal rates: Low = 10 μ L/min Medium = 60 μ L/min High = 120 μ L/min
Sample acquisition rate	10,000 events/sec with <10% abort rate (8 parameters)
Recommended maximum particle size	50 μ m

Signal Processing

Workstation resolution	262,144-channel resolution
Data acquisition channels	8 to 10 parameters: 6 to 8 fluorescent and 2 scatter parameters
Fluorescence compensation	No limit to inter- and intra-beam compensation
Pulse processing	Height, area, and width measurements available for any parameter (BD FACSDiva software)
Time	Can be correlated to any parameter
Channel threshold	Available for any parameter from all lasers

Fluidics Cart Specifications

Dimensions	Height: 64 cm (25.2 in.) Width: 79 cm (31.1 in.) Depth: 61 cm (24 in.)
Operational clearances	Fluidics cart, side air vent: 20 cm (7.9 in.) between air vent and other objects or wall to permit proper air flow Fluidics cart, door air vent: 20 cm (7.9 in.) between door and other objects or wall to permit proper air flow
Weight	≤51 kg (112 lb)—fluidics cart only, excluding tanks ≤82 kg (180 lb)—with tanks full
Facilities	No air supply or vacuum required

Capacity

BD FACSTFlow cubitainer	20 L
BD FACSClean solution cubitainer	5 L
BD FACS shutdown solution cubitainer	5 L
Waste tank	10 L

BD FACS Loader Specifications

Carousel compatibility	Loader carousels, numbers 1–16
Tube compatibility	
• Carousel	Accommodates up to 40 uncapped 12 x 75-mm tubes <ul style="list-style-type: none">• BD Falcon polystyrene test tubes• BD Trucount tubes• BD FACS 7-color setup bead tubes
• Thickness of accumulated labels	≤0.125 mm (5 mils) no more than 3 labels thick
Tube sample volume (maximum)	≤1.07 mL

Index

Numerics

7-color setup beads 32
label 30

A

achromatic focusing lens 20
air filter, replacing 60
air flow direction 62
air lock, removing 72
alarm
 fluid level 27
alcohol, isopropyl 75
alignment guide pin 34
array, detector 21
aspirator arm 16
 about 17
 bar 37
 about 17
assistance, technical xi
automatic mode 41
auxiliary air supply switch 28

B

Bal seal 79
 removal tool 80
Bal seal retainer 79
 saline deposits 74
bandpass (BP) filters 113

barcode

reader 30
 cleaning 48
 focal lengths 48
 installing 46
 symbolologies 49
BD FACS Loader 29
BD FACS Sample Prep Assistant II 13
BD FACS shutdown solution
 cubitainer 27
 changing 68
BD FACSClean solution
 cubitainer 27
 changing 68
BD FACSFlow solution
 cubitainer 27
 changing 68
beam geometry 148
beam-shaping prisms 20
bleeding filters 57
blue laser 19
breaker, main circuit 24
Bubble Filter Purge 66, 78
bypass tubing, installing 72, 73

C

cables
 fiber optic 20
 reconnecting 86
cap, waste tank 55

- carousel rack
 - about 35
 - installing 39
 - removing 38
 - troubleshooting 103
 - tubes, compatible 35, 151
- changing cubitainers 68
- circuit breaker
 - cytometer 24, 85
 - fluidics cart 28
 - resetting 98
- Clean Flow Cell 76
- cleaning
 - barcode reader 48
 - external surfaces 43, 74
 - flow cell 76
 - fluid 31, 75
 - fluidics for storage 79
 - Loader 43
 - SIT 76
- collection optics 19
- compensation theory 117
- components
 - FACSCanto system 15
 - fluidics cart 26
 - Loader 34
- condensation trap 29
- configuration, optics
 - 4-2 19, 126
 - 4-2-2 19, 130
 - 5-3 19, 134
- connecting power cords 24
- connection
 - fluid port 27
 - level-sensor connection 27
- container, waste 27

- cubitainer
 - BD FACS shutdown solution 27
 - BD FACSClean solution 27
 - BD FACSFlow solution 27
 - changing 68
- cytometer
 - circuit breaker 85
 - components 16
 - Loader mode 41
 - manual mode 40
 - not responding to software 98
 - power 24
 - side door 61

D

- decontamination 59
- de-gas flow cell 76
- detector 114
- detector array 21, 114
- diode, forward scatter 19
- direction, air flow 62
- doors
 - access 16
 - Loader 39
- dry tube, sample runs 102

E

- electronics system 24, 119
- embedded computer 123
- emitted light 18
- ethanol 75
- excitation optics 19

F

- fiber optic cables 20
- fiber optics 20

- filters
 - air, replacing 60
 - bandpass 113
 - bubble 78
 - changing 63
 - fluidic 26
 - longpass 22, 112
 - optical theory 112
 - purging 57
 - removing an air lock 72
 - waste tank cap 55
- flow cell 16, 19
 - about 17, 18, 20
 - access door 16, 18
 - cleaning 76
 - problems 96, 97
 - removing bubbles 76
- flow cytometry 106
- flow rates 149
- fluid
 - leaks
 - cytometer 99
 - fluidics cart 101
 - SIT 100
 - level alarm 27
 - not recommended 75
 - port connection 27
 - required 31
- fluidics
 - about 106
 - level sensors, replacing 89
 - long clean 59
 - priming 71
 - system components 16

- fluidics cart
 - components 26
 - controls 28
 - dimensions 150
 - fuses, replacing 92
 - maintenance 54, 68
 - reconnecting tubing 86
 - troubleshooting 98, 101
- fluorescence 111
 - detection 148
 - properties, particle 18
- fluorochromes 20
 - emission spectra 111
 - spectral overlap and 117
- focal lengths
 - barcode reader 48
- focusing lens 20
- forward scatter (FSC)
 - about 110
 - diode 19
- fuses, replacing 92

G

- granularity, particle 18
- guide, tube 34

H

- hydrodynamic focusing 108

I

- in vitro diagnostic device 14
- installation kit 140

- installing
 - air filter 60
 - barcode reader 46
 - bypass tubing 73
 - carousel rack 39
 - cubitainers 68
 - fluidics level sensors 89
 - fuses 92
- instrument
 - cleaning 74
 - power 24
 - QC particles 142
 - specifications 146, 150
 - supplies 140
- intended use statement 14
- interlock
 - laser path 20
 - safety 20
- isopropyl alcohol 75

L

- label thickness 151
- laser 20
 - air-cooled 20
 - blue 19
 - Coherent Sapphire Solid State 20, 126, 130, 134
 - interlock 20
 - JDS Uniphase HeNe Air Cooled 20, 126, 130, 134
 - Point Source iFLEX 130
 - power 24
 - red 19
 - safety interlock 20
 - solid state 20
 - specifications 147
 - troubleshooting 99
 - violet 19

- leaks
 - cytometer 99
 - fluidics cart 101
 - SIT 100
- lens
 - achromatic focusing 20
- level sensor 89
- level-sensor connection 27
- lifter, tube 34
- light
 - scattered and emitted 18
- Loader
 - about 29
 - adapting cytometer 41
 - cleaning 43
 - components 34
 - doors
 - opening 39
 - opening and closing 36
 - drawer 35
 - drive system 35
 - spindle 34
- long clean 59
- longpass
 - filter 22, 112
 - mirror 22

M

- maintenance
 - barcode reader 48
 - Loader 43
 - scheduled 52
 - unscheduled 66
- manual mode 40
- mirror, longpass 22
- modes
 - automatic loading 41
 - manual loading 40

O

- obscurator bar 19, 22
- octagon 114
 - optics 21, 23
- operating temperature 147
- optical sensors 34
- Opticon LG2 Imager 30, 46
- optics
 - 4-2 configuration 19
 - 4-2-2 configuration 19
 - 5-3 configuration 19
 - about 109
 - access door 16
 - collection 19
 - components 19
 - excitation 19
 - fiber 20
 - filters and mirrors 23
 - filters, theory 112
 - optical pathway 20
- ordering supplies 139

P

- particle
 - fluorescence properties 18
 - granularity 18
 - shape 18
 - size 18
- photodiode 19, 22, 114
- photomultiplier tube (PMT) 21, 114
- pin, alignment 34
- plenum 16, 18
 - about 106
- PMT 114
- power
 - button 16, 24
 - instrument 24
 - laser 24

- pressure, sheath fluid 107
- priming, fluid lines 71
- prisms 20
 - beam-shaping 20
- pulse 120
 - area 122
 - height 122
- purging filters 57

R

- rack, carousel 151
- red laser 19
- removing carousel rack 38
- replacing
 - air filter 60
 - fuses 92
- requirements, system 31

S

- safety interlock 20
- sample injection tube (SIT) 16
 - cleaning 76
 - problems 97, 99, 100
- sample prep worklist 13
- sample stream 19
- scattered light 18, 110
- scheduled maintenance 52
- seal, Bal 79
- sensitivity, cytometer performance 147
- sensors, fluidics 89
- shape, particle 18
- sheath fluid
 - consumption 149
 - pressure 107
- side door, cytometer 16
- side scatter (SSC) 110
- SIT 16
 - about 17

- size, particle 18
- specifications 151
 - cytometer 146
 - fluidics cart 150
- spectral overlap 118
- spillover 117
- spindle, Loader 34, 35
- stream, sample 19
- supplies, instrument 140
- symbologies, barcode 49
- system requirements 31

T

- technical
 - assistance xi
 - specifications 151
- trap
 - condensation 29
- trigon 114
 - optics 21, 23
- troubleshooting 102
- tube
 - eject cylinder 17
 - guide 34, 37
 - about 17
 - sensor 17
 - wet 18
- tubes
 - compatible 35
 - lifter 34
 - sample volume 151
- tubing
 - about 17
 - network 16

U

- unscheduled maintenance 66

V

- violet laser 19
- voltage, fluidics cart fuses 94

W

- waste
 - cap 55
- waste container 27
 - emptying 54
- worklist, sample prep 13